

MAX43[®]

**Plasma Arc
Cutting System**

***Instruction Manual
801290 - Revision 13***



**EN50199
EN50192**

Hypertherm
***The world leader in
plasma cutting technology***

MAX43[®]
Plasma Arc Cutting System

Instruction Manual
IM-129
(P/N 801290)

Revision 13 March, 1999

Hypertherm, Inc.
Hanover, NH USA
<http://www.hypertherm.com>
[email:info@hypertherm.com](mailto:info@hypertherm.com)

© Copyright 1999 Hypertherm, Inc.
All Rights Reserved

Hypertherm and MAX are trademarks of Hypertherm, Inc.
and may be registered in the United States and/or other countries

Hypertherm Offices Worldwide:

Hypertherm, Inc.

Etna Road, P.O. Box 5010
Hanover, NH 03755 USA
Tel.: (603) 643-3441 (Main Office)
Fax: (603) 643-5352 (All Departments)
Tel.: (800) 643-9878 (Technical Service – toll-free in USA and Canada)
Tel.: (800) 737-2978 (Customer Service – toll-free in USA and Canada)
email: info@hypertherm.com (General Information)
email: service@hypertherm.com (Technical/Customer Services)

Hypertherm Plasmatechnik GmbH

Technologiepark Hanau
Rodenbacher Chaussee 6
D-63457 Hanau-Wolfgang, Germany
Tel.: 49 6181 58 2100
Fax: 49 6181 58 2134

Hypertherm (S) Pte Ltd

No. 19 Kaki Bukit Road 2
K.B. Warehouse Complex
Singapore 417847
Tel.: 65 841 2489
Fax: 65 841 2490

Hypertherm UK Ltd

9 Berkeley Court, Manor Park
Runcorn, Cheshire, England WA7 1TQ
Tel.: 44 1928 579 074
Fax: 44 1928 579 604

France

15 Impasse des Rosiers
95610 Eragny, France
Tel.: 33 1 30 37 15 28
Fax: 33 1 30 37 15 79

Hypertherm S.r.L.

Via Torino 2
20123 Milan, Italy
Tel.: 39 02 725 46 312 (Customer Service)
Tel.: 39 02 725 46 314 (Technical Service)
Fax: 39 02 725 46 400 (All Departments)

Hypertherm B.V.

Burg, Haverkampstraat 13
7091 CN Dinxperlo, The Netherlands
Tel.: 31 315 655 866 (Customer Service)
Fax: 31 315 655 886

European Technical Support Organization (ETSO)

Edisonstraat 12
3281 NC Numansdorp, The Netherlands
Tel.: 00 800 4973 7843 (00 800 Hypertherm) – (toll-free Technical Service)
Tel.: 31 186 659494
Fax: 31 186 659495

Japan

Shinjuku Park Tower
30th Floor
3-7-1 Nishi-Shinjuku
Shinjuku-ku, Tokyo
163-1030, Japan
Tel.: 81 03 5326 3142
Fax: 81 03 5326 3001

ELECTROMAGNETIC COMPATIBILITY (EMC)

EMC INTRODUCTION

This plasma cutting equipment has been built in compliance with standard EN50199. To ensure that the equipment works in a compatible manner with other radio and electronic systems, the equipment should be installed and used in accordance with the information below to achieve electromagnetic compatibility.

The limits required by EN50199 may not be adequate to completely eliminate interference when the affected equipment is in close proximity or has a high degree of sensitivity. In such cases it may be necessary to use other measures to further reduce interference.

This plasma equipment should be used only in an industrial environment. It may be difficult to ensure electromagnetic compatibility in a domestic environment.

INSTALLATION AND USE

The user is responsible for installing and using the plasma equipment according to the manufacturers instructions. If electromagnetic disturbances are detected then it shall be the responsibility of the user to resolve the situation with the technical assistance of the manufacturer. In some cases this remedial action may be as simple as earthing the cutting circuit, see *Earthing of Workpiece*. In other cases it could involve constructing an electromagnetic screen enclosing the power source and the work complete with associated input filters. In all cases electromagnetic disturbances must be reduced to the point where they are no longer troublesome.

ASSESSMENT OF AREA

Before installing the equipment the user shall make an assessment of potential electromagnetic problems in the surrounding area. The following shall be taken into account:

- a. Other supply cables, control cables, signalling and telephone cables; above, below and adjacent to the cutting equipment.
- b. Radio and television transmitters and receivers.
- c. Computer and other control equipment.
- d. Safety critical equipment, for example guarding of industrial equipment.
- e. Health of the people around, for example the use of pacemakers and hearing aids.

f. Equipment used for calibration or measurement.

g. Immunity of other equipment in the environment. User shall ensure that other equipment being used in the environment is compatible. This may require additional protection measures.

h. Time of day that cutting or other activities are to be carried out.

The size of the surrounding area to be considered will depend on the structure of the building and other activities that are taking place. The surrounding area may extend beyond the boundaries of the premises.

METHODS OF REDUCING EMISSIONS

Mains Supply

Cutting equipment should be connected to the mains supply according to the manufacturers recommendations. If interference occurs, it may be necessary to take additional precautions such as filtering of the mains supply. Consideration should be given to shielding the supply cable of permanently installed cutting equipment, in metallic conduit or equivalent. Shielding should be electrically continuous throughout its length. The shielding should be connected to the cutting mains supply so that good electrical contact is maintained between the conduit and the cutting power source enclosure

Maintenance of Cutting Equipment

The cutting equipment should be routinely maintained according to the manufacturers recommendations. All access and service doors and covers should be closed and properly fastened when the cutting equipment is in operation. The cutting equipment should not be modified in any way except for those changes and adjustments covered in the manufacturers instructions. In particular, the spark gaps of arc striking and stabilizing devices should be adjusted and maintained according to the manufacturer's recommendations.

Cutting Cables

The cutting cables should be kept as short as possible and should be positioned close together, running at or close to the floor level.

Equipotential Bonding

Bonding of all metallic components in the cutting installation and adjacent to it should be considered. However, metallic components bonded to the workpiece will increase the risk that the operator could receive a shock by touching these metallic components and the electrode at the same time. The operator should be insulated from all such bonded metallic components.

Earthing of Workpiece

Where the workpiece is not bonded to earth for electrical safety, nor connected to earth because of its size and position, for example, ship's hull or building steelwork, a connection bonding the workpiece to earth may reduce emissions in some, but not all instances. Care should be taken to prevent the earthing of the workpiece increasing the risk of injury to users, or damage to other electrical equipment. Where necessary, the connection of the workpiece to earth should be made by a direct connection to the workpiece, but in some countries where direct connection is not permitted, the bonding should be achieved by suitable capacitances selected according to national regulations.

Note. The cutting circuit may or may not be earthed for safety reasons. Changing the earthing arrangements should only be authorized by a person who is competent to assess whether the changes will increase the risk of injury, for example, by allowing parallel cutting current return paths which may damage the earth circuits of other equipment. Further guidance is given in IEC TC26 (sec)94 and IEC TC26/108A/CD Arc Welding Equipment Installation and Use.

Screening and Shielding

Selective screening and shielding of other cables and equipment in the surrounding area may alleviate problems of interference. Screening of the entire plasma cutting installation may be considered for special applications.

WARRANTY



ATTENTION



Genuine Hypertherm parts are the factory-recommended replacement parts for your Hypertherm system. Use of other than genuine Hypertherm parts may be cause for invalidation of the Hypertherm warranty.

GENERAL

HYPERTHERM, Inc. warrants that Products shall be free from defects in materials and workmanship, under proper and normal use for which such Equipment is recommended, for a period of two (2) years, except only with respect to the Torch, for which the warranty period shall be one (1) year, from the date of its delivery to you or to a customer by you, BUT IN NO EVENT SHALL THIS WARRANTY EXTEND BEYOND 36 MONTHS FROM THE DATE OF ORIGINAL DELIVERY TO YOU BY HYPERTHERM.

HYPERTHERM, at its sole option, shall repair, replace, or adjust, free of charge, any Products covered by this warranty which shall be returned with HYPERTHERM's prior authorization (which shall not be unreasonably withheld), properly packed, to HYPERTHERM's place of business in Hanover, New Hampshire, all costs, insurance and freight prepaid, and which examination proves not to be free from defects in materials and workmanship. HYPERTHERM shall not be liable for any repairs, replacements, or adjustments of Products covered by this warranty, except those made pursuant to this paragraph or with HYPERTHERM's written consent. This warranty shall not apply to any Product which has been mishandled, incorrectly installed, modified or assembled by you or any other person. HYPERTHERM shall be liable for breach of this warranty only if it receives written notice of such breach within the applicable warranty period specified herein above. THE FOREGOING SHALL CONSTITUTE THE SOLE REMEDY TO DISTRIBUTORS OR THEIR CUSTOMERS FOR ANY BREACH BY HYPERTHERM OF ITS WARRANTY.

PATENT INDEMNITY

Except only in cases of Products not manufactured by HYPERTHERM or manufactured by a person other than HYPERTHERM not in strict conformity with HYPERTHERM's specifications, and in cases of designs, processes, formulae or combinations not developed or purported to be developed by HYPERTHERM, HYPERTHERM agrees to indemnify, protect and hold harmless Distributors and their customers against any and all liability or claims in any manner imposed upon or accruing against Distributors and their customers because of the use in or about the construction or operation of Equipment or any design, system, formula, combination, article or material which infringes or alleges to infringe on any patent or other right. Distributors shall notify HYPERTHERM promptly upon learning of any action or threatened action in connection with any such alleged infringement, and each party may appoint its own counsel for any such action or threatened action.

DISCLAIMER OF OTHER WARRANTIES

HYPERTHERM MAKES NO WARRANTIES REGARDING PRODUCTS MANUFACTURED BY IT OR OTHERS (INCLUDING WITHOUT IMPLIED LIMITATION WARRANTIES AS TO MERCHANTABILITY OR FITNESS FOR A PARTICULAR PURPOSE), EITHER EXPRESS OR IMPLIED, EXCEPT AS PROVIDED HEREIN. This warranty is in lieu of any and all warranties, express or implied, by law or otherwise; and Distributors are not authorized to give any other warranty purporting to be binding upon HYPERTHERM upon resale of Products to their customers. IN NO EVENT shall HYPERTHERM be liable for incidental or consequential damages or injury to the person or property of anyone by reason of any defect in any Equipment sold hereunder.

TABLE OF CONTENTS

ELECTROMAGNETIC COMPATIBILITY (EMC)	i
WARRANTY	ii
SECTION 1 SAFETY	1-1
About Notes, Cautions and Warnings	1-1
Safety Instructions	1-2
Eye Protection	1-2
Skin Protection	1-2
Toxic Fume Prevention	1-2
Fire Prevention	1-2
Electric Shock Prevention	1-2
Explosion Prevention	1-3
Compressed Gas Cylinders	1-3
Pressure Regulators	1-3
Hoses	1-3
Noise Protection	1-4
Grounding	1-4
Input Power	1-4
Work Cable	1-4
Work Table	1-4
Safety Reminders	1-4
Electronic Health Support Equipment	1-4
SECTION 1a SÉCURITÉ	1a-1
Au sujet des Notes, Attention et Avertissements	1a-1
Consignes de sécurité	1a-2
Protection des yeux	1a-2
Protection de la peau	1a-2
Prévention des vapeurs toxiques	1a-2
Prévention des incendies	1a-2
Prévention des chocs électriques	1a-2
Prévention des explosions	1a-3
Bouteilles de gaz comprimé	1a-3
Détendeurs	1a-3
Tuyaux	1a-3
Protection contre le bruit	1a-4
Mise à la masse et à la terre	1a-4
Alimentation	1a-4
Câble de retour	1a-4
Table de travail	1a-4
Rappels de sécurité	1a-4
Prothèses électroniques	1a-4

TABLE OF CONTENTS

SECTION 2 SPECIFICATIONS	2-1
General	2-2
Description of Equipment	2-3
Specifications	2-3
MAX43 Power Supplies (Non CE)	2-3
MAX43 CE 400V Power Supply	2-4
Gas Requirements	2-4
PAC125T T rigger Torch	2-4
PAC125M M achine Torch (Optional)	2-4
PAC121P Pushbutton Torch (Option for Non CE Systems Only)	2-4
IEC Symbols Used	2-5
SECTION 3 SETUP	3-1
Upon Receipt	3-2
208-Volt Operation	3-2
Upon Receipt	3-2
208-Volt Operation	3-2
Power Requirements	3-3
Non CE Power Supplies	3-3
CE 400V Power Supply	3-3
Power Cord	3-3
Non CE 400V and 480V Power Supplies	3-3
CE 400V Power Supply	3-3
Grounding	3-3
Work Cable	3-4
Torch Lead Connection	3-4
PAC125M On/Off Pendant Connection	3-4
PAC125M Torch On/Off Switch Connection Data	3-5
Machine Interface Cable and Signal Data (Non CE Units Only)	3-5
Torch Alignment	3-5
Gas Supply Requirements	3-6
Shop Compressed Air	3-6
Cylinder Compressed Air	3-6
Nitrogen	3-6
SECTION 4 OPERATION	4-1
Front Panel Controls	4-2
Rear Panel Controls	4-3
Operating Instructions	4-4
Operating Tips	4-6
Changing Consumable Parts	4-6
PAC125T Safety Trigger Operation	4-7
Cutting	4-8
Piercing	4-10
Gouging	4-10
Common Cutting Faults	4-12
Duty Cycle	4-12
Gas Pressure	4-12
Torch Heat	4-12
Claims and Technical Questions	4-12
Operating Data Chart	4-13

TABLE OF CONTENTS

SECTION 5 MAINTENANCE	5-1
General	5-2
Power Supply	5-2
Torch and Torch Leads	5-2
Sequence of Operation	5-3
Problems and Solutions	5-4
PAC125T Torch Parts Removal and Replacement	5-6
Torch Main Body Removal and Replacement	5-6
Torch Switch Removal and Replacement	5-7
PAC121P Torch Parts Removal and Replacement	5-8
Torch Main Body Removal and Replacement	5-8
Torch Switch Removal and Replacement	5-8
PAC125M Torch Parts Removal and Replacement	5-10
Removal	5-10
Replacement	5-11
Quick Disconnect O-Ring Removal and Replacement	5-12
SECTION 6 MAX43 PARTS LIST	6-1
MAX43 Power Supplies with PAC125T Torch and Leads	6-2
MAX43 Power Supplies with No Torch	6-2
MAX43 CE 400V Power Supply	6-3
MAX43 CE 400V Hand and Machine Systems	6-3
Torch Assemblies and Leads	6-4
PAC125T Torch Assembly and Lead	6-4
PAC121P Torch Assembly and Lead	6-6
PAC125M Torch Assembly and Lead	6-8
On/Off Pendant	6-8
Shielded Consumable Parts	6-10
Nonshielded Consumable Parts	6-12
SECTION 7 STANDARDS INDEX	7-1

Section 1 SAFETY

In this section:

About Notes, Cautions and Warnings.....	1-1	Pressure Regulators	1-3
Safety Instructions	1-2	Hoses.....	1-3
Eye Protection.....	1-2	Noise Protection.....	1-4
Skin Protection	1-2	Grounding	1-4
Toxic Fume Prevention	1-2	Input Power.....	1-4
Fire Prevention.....	1-2	Work Cable	1-4
Electric Shock Prevention.....	1-2	Work Table	1-4
Explosion Prevention	1-3	Safety Reminders.....	1-4
Compressed Gas Cylinders.....	1-3	Electronic Health Support Equipment.....	1-4

Before using this plasma arc system. . . .

Each person who will operate this equipment, perform service or maintenance, or supervise its use must read the safety instructions and warnings in this manual and the labels on the equipment.

About Notes, Cautions and Warnings

Notes: Throughout this manual, useful information for operating the plasma system is presented in “notes”, such as shown in this paragraph.

Cautions: Information in bold type and surrounded by a box describes a situation that may cause damage to the plasma system.



WARNINGS



Warnings describe situations that present a physical danger to the operator, and advice to avoid or correct the situation. Each type of warning includes applicable danger symbols, such as a hand burn, electrical shock, fire, explosion, etc.



WARNING — Instant-On Torches

Instant-on torches produce a plasma arc immediately after the torch switch is pushed.

Always hold a hand torch away from your body as a precaution against accidental torch firing. Be aware of this hazard, which has potential for serious bodily injury.





WARNING — Electric Shock

- Never touch the torch body, workpiece or the water in a water table when operating the plasma system.
- When using a water table, be sure that it is correctly connected to earth ground.
- Operating the plasma system completes an electrical circuit between the torch and the workpiece and anything touching the workpiece. The workpiece is part of the electrical circuit.

Eye Protection

- Wear dark safety glasses or goggles with side shields, or a welding helmet, in accordance with applicable national or local codes, to protect eyes against the plasma arc's ultraviolet and infrared rays.

Arc Current		Lens Shade	
		AWS (USA)	ISO 4850
Up to 100 A		No. 8	No. 11
100–200 A		No. 10	No. 11-12
200–400 A		No. 12	No. 13
Over 400 A		No. 14	No. 14

- Replace the glasses, goggles or helmet when the lens becomes pitted or broken.
- Warn other people in the area not to look directly at the arc unless they are wearing glasses, goggles or a helmet.
- Prepare the cutting area in a manner that reduces the reflection and transmission of ultraviolet light:
 - Paint walls and other surfaces with dark colors to reduce reflection.
 - Install protective screens or curtains to reduce ultraviolet transmission.

Skin Protection

- Wear protective clothing to protect against burns caused by ultraviolet light, sparks and hot metal:
 - Gauntlet gloves, safety shoes and hat.
 - Flame-retardant clothing which covers all exposed areas.
 - Cuffless trousers to prevent entry of sparks and slag.

Toxic Fume Prevention

- Keep the cutting area well ventilated.
- Remove all chlorinated solvents from the cutting area before cutting. Certain chlorinated solvents decompose when exposed to ultraviolet radiation to form phosgene gas.
- Wear proper breathing mask and use proper ventilation when cutting galvanized metal.
- Do not cut containers with toxic materials inside. Clean containers that have held toxic materials thoroughly before cutting.



WARNING — Toxic Fumes

Do not cut metal or painted metals containing zinc, lead, cadmium or beryllium unless the operator, or anyone else subjected to the fumes, wears respiratory equipment or an air-supplied helmet.



Fire Prevention



- Make fire extinguishers available in the cutting area.
- Remove combustible material from the immediate cutting area to a distance of at least 35 feet (10 m).
- Quench freshly cut metal or allow metal to cool before handling it or bringing it into contact with combustible materials.
- Never use a plasma system to cut containers with potentially flammable materials inside. Such containers must be thoroughly cleaned prior to cutting.
- Ventilate potentially flammable atmospheres before cutting with a plasma system. When cutting with oxygen as the plasma gas, an exhaust ventilation system is required.
- Never operate the plasma system in an atmosphere which contains heavy concentrations of dust, flammable gas or combustible liquid vapors unless properly vented.

Electric Shock Prevention



All Hypertherm plasma systems use high voltage (up to 300 VDC) to initiate the plasma arc. Take the following precautions when operating the plasma system:

- Wear insulated gloves and boots, and keep body and clothing dry.
- Do not stand, sit or lie on—or touch—any wet surface when using the plasma system.
- Maintain proper insulation against electrical shock. If you must work in or near a damp area, use extreme caution.
- Provide a wall-mounted disconnect switch with properly sized fuses close to the power supply. This switch allows the operator to turn the power supply off quickly in an emergency situation.
- Conform to all local electrical codes for primary wiring sizes and types.
- Inspect the primary power cord frequently for damage or cracking of the cover. Bare wiring can kill. Do not use a system with a damaged power cord. Replace a damaged power cord immediately.
- Inspect the torch leads. Replace if frayed or damaged.
- Do not pick up the workpiece, including the waste cutoff, while you cut. Leave the workpiece in place or on the workbench with the work cable attached during the cutting process.

Electric Shock Prevention (continued)

- Before changing the torch parts, disconnect the main power or unplug the power supply. After changing torch parts and replacing the retaining cap, plug in the power supply again.
- Never bypass or shortcut the safety interlocks.
- Before removing a power supply cover for maintenance, disconnect the main power at the wall disconnect switch or unplug the power supply. To avoid exposure to severe electrical hazard, wait five minutes after disconnecting the main power to allow capacitors to discharge.
- Never operate the plasma system unless the power supply unit covers are in place. Exposed power supply connections present a severe electrical hazard.

Explosion Prevention



WARNING — Compressed Gas

The plasma system uses compressed gas. Observe proper precautions when handling and using compressed gas equipment and cylinders.

- Do not use the plasma system if explosive dust or vapors may be present.
- Do not cut pressurized cylinders or any closed container.



WARNING — Hydrogen Explosion Hazard

If your system uses hydrogen, remember that this is a flammable gas that presents an explosion hazard. Keep flames away from cylinders containing hydrogen mixtures and hoses that carry hydrogen mixtures. Also, keep flames and sparks away from the torch when using argon-hydrogen as the plasma gas.

Compressed Gas Cylinders

Handle and use compressed gas cylinders in accordance with safety standards published by the U.S. Compressed Gas Association (CGA), American Welding Society (AWS), Canadian Standards Association (CSA) or applicable national or local codes.

- Never use a cylinder that leaks or is physically damaged.

- Never use a cylinder that is not upright and secured in place.
- Never move or transport a cylinder without its protective valve cover in place.
- Never use a gas cylinder or its contents for any purpose other than that for which it is intended.
- Never lubricate cylinder valves with oil or grease.
- Never allow electrical contact between the plasma arc and a cylinder.
- Never expose cylinders to excessive heat, sparks, slag or open flame.
- Never use hammers, wrenches or other tools to open stuck cylinder valves.

Pressure Regulators

- Be certain that all pressure regulators are in proper working condition.
- Never use a regulator for any gas other than that for which it is intended.
- Never use a regulator that leaks, creeps excessively or is physically damaged in any way.
- Never attempt to lubricate a regulator with oil or grease.



WARNING — Hydrogen Detonation with Aluminum Cutting

When cutting aluminum underwater, or with the water touching the underside of the aluminum, free hydrogen gas may collect under the workpiece and detonate during plasma cutting operations.

Installing an aeration manifold on the floor of the water table is an effective way to eliminate the possibility of hydrogen detonation when cutting aluminum. Refer to the Appendix section of this manual for instructions on how to fabricate an aeration manifold.

Hoses

- Label and color-code all gas hoses in order to clearly identify the type of gas in each hose. Consult applicable national or local codes.
- Never use the oxygen hose for any gas other than oxygen.
- Examine hoses at regular intervals for leaks, wear, loose connections or other hazard.
- Replace hose that is damaged in any way.

Hoses (continued)

- Keep hose lengths to a minimum to prevent damage, reduce pressure drop and to prevent possible flow restrictions.
- Prevent kinking by laying out hoses as straight as possible between termination points.
- Coil any excess hose and place it out of the way to prevent damage and to eliminate the danger of tripping.

Noise Protection



The plasma cutting process can generate high levels of noise. Depending on the arc current, material being cut, acoustics and size of the cutting room, distance from the torch and other factors, acceptable noise levels as defined by national or local codes may be exceeded by your plasma system.

- Always wear proper ear protection when cutting or gouging with the plasma system.

Grounding

Input Power

- Be sure to connect the power cord ground wire to the ground in the disconnect box.
- If installation of the plasma system involves connecting the power cord to the power supply, be sure to properly connect the power cord ground wire. Conform to Canadian Standards Association (CSA) standards by placing the power cord ground wire on the stud first; then place any other ground wires on top of the power cord ground. Fasten the retaining nut tightly.
- Tighten all electrical connections to avoid excessive heating.

Work Cable

- Attach the work cable securely to the workpiece or the work table by making good metal-to-metal contact. Do not connect it to the piece that will fall away when the cut is complete.

Work Table

- Connect the work table to an earth ground, in accordance with appropriate national or local codes.

Safety Reminders

- Never bypass or shortcut the safety interlocks on any of the plasma system units.
- Except in Hypertherm's largest mechanized systems, all Hypertherm torches are designed with a safety interlock that prevents firing of the plasma arc when the retaining cap is loosened.
- Each Hypertherm plasma system is designed to be used only with specific Hypertherm torches. Do not substitute other torches which could overheat and present a potentially dangerous situation to the operator and any personnel in the area. Hypertherm's warranty does not cover problems caused by the use of torches not made by Hypertherm.
- Use only consumable parts and replacement parts made by Hypertherm. Hypertherm's warranty does not cover problems caused by the use of parts not made by Hypertherm.
- Never operate the plasma system with any of its covers not in place. This would be hazardous to the operator and other people in the area, and prevents the proper cooling of the equipment.

Electronic Health Support Equipment

Plasma arc cutting and gouging systems create electric and magnetic fields that may interfere with the correct operation of electronic health support equipment, such as pacemakers or hearing aids. Any person who wears a pacemaker or hearing aid should consult a doctor before operating or being near any plasma system when it is in use. To minimize exposure to EMF:

- Keep both the work cable and the torch lead on one side of your body. Keep your body from coming in between the torch lead and the work cable.
- Route torch leads as close as possible to work cable.
- Do not wrap the torch lead or work cable around your body.
- Stay as far away from the power supply as possible.

Section 1 SÉCURITÉ

Cette section comprend :

Au sujet des Notes, Attention et Avertissements	1a-1	Détendeurs	1a-3
Consignes de sécurité.....	1a-2	Tuyaux.....	1a-3
Protection des yeux	1a-2	Protection contre le bruit	1a-4
Protection de la peau.....	1a-2	Mise à la masse et à la terre	1a-4
Prévention des vapeurs toxiques.....	1a-2	Alimentation	1a-4
Prévention des incendies.....	1a-2	Câble de retour	1a-4
Prévention des chocs électriques	1a-2	Table de travail	1a-4
Prévention des explosions.....	1a-3	Rappels de sécurité.....	1a-4
Bouteilles de gaz comprimé	1a-3	Prothèses électroniques	1a-4

Avant d'utiliser ce système de coupage plasma...

Chaque personne qui utilise, répare ou entretient l'appareil ou en surveille l'emploi, doit lire les consignes de sécurité et les avertissements donnés dans ce manuel et sur les étiquettes du matériel.

Au sujet des rubriques Notes, Attention et Avertissements

Notes : Sous cette rubrique, on donne des conseils pratiques pour utiliser le système plasma.

Attention : Les informations en caractères gras et encadrées décrivent une situation qui risquerait d'endommager le système plasma.



AVERTISSEMENTS



Un avertissement décrit des situations qui présentent un danger physique pour l'opérateur, et donne des conseils pour éviter ou rectifier ce problème. Chaque type d'avertissement est accompagné d'un symbole de danger correspondant, comme une brûlure aux mains, un feu, une explosion, un choc électrique, etc.



AVERTISSEMENT — Torches à allumage instantané

Les torches à allumage instantané produisent un arc plasma immédiatement après avoir appuyé sur le bouton d'allumage de la torche.

Par précaution, maintenez toujours la torche éloignée de votre corps en cas d'un allumage accidentel. Prenez garde à ce danger qui risque de provoquer des blessures graves.





AVERTISSEMENT — Chocs électriques

- Ne jamais toucher le corps de la torche, la pièce à couper ou l'eau de la table à eau quand on utilise le système plasma.
- Quand on utilise une table à eau, s'assurer qu'elle est bien mise à la terre.
- Quand on utilise le système plasma, on établit un circuit électrique entre la torche et la pièce à couper et avec tout ce qui touche la pièce. La pièce à couper fait partie intégrante du circuit électrique.

SÉCURITÉ

Protection des yeux

- Porter des lunettes de sécurité à verres teintés ou des lunettes-masque munies d'écrans latéraux ou encore un masque à serre-tête, conformément aux codes nationaux ou locaux applicables, pour se protéger contre les rayons ultraviolets et infrarouges de l'arc.

Courant de l'arc		Pouvoir obscurcissant des verres	
		AWS (É.-U.)	ISO 4850
Jusqu'à 100 A		N° 8	N° 11
100-200 A		N° 10	N° 11-12
200-400 A		N° 12	N° 13
Plus de 400 A		N° 14	N° 14

- Remplacer les lunettes, les lunettes-masque ou le masque à serre-tête quand les verres sont rayés ou cassés.
- Avertir les autres personnes se trouvant sur les lieux de travail de ne pas regarder directement l'arc, à moins qu'elles ne portent des lunettes, des lunettes-masque ou un masque à serre-tête.
- Préparer le poste de coupage de façon à réduire la réflexion et la transmission des rayons ultraviolets :
 - Peindre les murs et autres surfaces de couleur foncée pour réduire la réflexion.
 - Installer des écrans ou des rideaux protecteurs pour réduire la transmission des rayons ultraviolets.

Protection de la peau

- Porter des vêtements de sécurité pour se protéger contre les brûlures que peuvent causer les rayons ultraviolets, les étincelles et le métal brûlant :
 - Gants à crispin, chaussures et casque de sécurité.
 - Vêtements ignifuges couvrant toutes les parties du corps exposées.
 - Pantalon sans revers pour éviter que des étincelles ou des scories puissent s'y loger.

Prévention des vapeurs toxiques

- Tenir le poste de coupage bien aéré.
- Avant le coupage, enlever tous les solvants chlorés du poste de coupage. Certains solvants chlorés se décomposent sous l'effet des rayons ultraviolets et forment du phosgène.
- Porter un masque respiratoire approprié lors du coupage de métaux galvanisés, et s'assurer que la ventilation est efficace.
- Ne pas couper des réservoirs contenant des matières toxiques. Avant le coupage, nettoyer soigneusement les réservoirs qui ont contenu des matières toxiques.

Prévention des incendies



- S'assurer qu'il y a des extincteurs au poste de coupage.
- Éloigner les matières inflammables d'au moins 10 m du poste de coupage.
- Tremper le métal que l'on vient de couper ou le laisser refroidir avant de le manipuler ou de le mettre en contact avec des matériaux inflammables.
- Ne jamais utiliser un système plasma pour couper des réservoirs contenant des matières potentiellement inflammables. De tels récipients doivent être soigneusement nettoyés avant le coupage.
- Aérer toute atmosphère potentiellement inflammable avant de couper avec un système plasma. Quand on utilise l'oxygène comme gaz plasma, il faut utiliser un système de ventilation par aspiration.
- Ne jamais faire fonctionner le système plasma dans une atmosphère qui contient une forte concentration de poussière, de gaz inflammable ou de vapeurs de liquides inflammables, à moins que l'on utilise une bonne ventilation.

Prévention des chocs électriques



- Tous les systèmes de coupage Hypertherm utilisent une haute tension (jusqu'à 300 V c.c.) pour amorcer l'arc plasma. On doit prendre les précautions suivantes quand on utilise le système plasma :
- Porter des gants et des bottes isolants et garder le corps et les vêtements au sec.
 - Ne pas se tenir, s'asseoir, se coucher sur une surface mouillée, ni la toucher, quand on utilise le système plasma.
 - Bien s'isoler contre les chocs électriques. Agir avec la plus grande prudence quand l'on doit travailler près ou à l'intérieur d'une zone humide.
 - Installer un sectionneur mural avec fusibles appropriés, à proximité de la source de courant. Ce dispositif permet à l'opérateur d'arrêter rapidement la source de courant en cas d'urgence.
 - Se conformer aux codes électriques de la région au point de vue des types et des grosseurs du câblage primaire.
 - Inspecter fréquemment le cordon d'alimentation primaire pour s'assurer qu'il n'est ni endommagé, ni fissuré. Un câble dénudé peut tuer. Ne pas utiliser le système si le cordon d'alimentation est endommagé. Si tel est le cas, remplacer immédiatement le cordon.
 - Inspecter les câbles ou tuyaux de la torche. Les remplacer s'ils sont effilochés ou endommagés.
 - Ne pas saisir la pièce à couper ni les chutes lors du coupage. Laisser la pièce à couper en place ou sur la table de travail, le câble de retour connecté lors du coupage.



AVERTISSEMENT —
Vapeurs toxiques



Ne pas couper des métaux (peints ou non) qui contiennent du zinc, du plomb, du cadmium ou du béryllium, à moins que l'utilisateur et toute personne exposée aux vapeurs ne portent un appareil respiratoire ou un masque à adduction d'air.

Prévention des chocs électriques (suite)

- Avant de remplacer les pièces de la torche, couper l'alimentation ou débrancher la source de courant. Après avoir remplacé les pièces de la torche et remis en place la buse de protection, rebrancher la source de courant.
- Ne jamais contourner ou court-circuiter les verrouillages de sécurité.
- Avant d'enlever le capot de la source de courant pour effectuer l'entretien, couper l'alimentation au sectionneur mural ou débrancher. Attendre cinq minutes pour que les condensateurs se déchargent ; sinon on s'expose à des chocs importants.
- Ne jamais faire fonctionner le système plasma sans que le capot de la source de courant soit en place. Les raccords exposés de la source de courant sont extrêmement dangereux.

Prévention des explosions



AVERTISSEMENT — Gaz comprimé

Le système plasma utilise du gaz comprimé. Prendre les précautions nécessaires quand on manutentionne et utilise des appareils et des bouteilles à gaz comprimé.

- Ne pas couper en présence de poussière ou de vapeurs explosives.
- Ne pas couper des bouteilles sous pression ni des réservoirs fermés.



AVERTISSEMENT — Risque d'explosion de l'hydrogène

Si le système utilise de l'hydrogène, se rappeler que c'est un gaz inflammable qui présente un danger d'explosion. Tenir toute flamme éloignée des bouteilles et des tuyaux contenant des mélanges d'hydrogène. Tenir également la torche plasma éloignée de toute flamme ou étincelle lorsque le gaz plasma est constitué d'un mélange argon-hydrogène.

Bouteilles de gaz comprimé

Manipuler et utiliser les bouteilles de gaz comprimé conformément aux normes de sécurité publiées par la Compressed Gas Association (CGA), l'American Welding Society (AWS), l'Association canadienne de normalisation (ACNOR/CSA) ou les codes nationaux ou locaux.

- Ne jamais utiliser une bouteille qui fuit ou est endommagée.

- Ne jamais utiliser une bouteille qui n'est pas placée à la verticale et bien assujettie.
- Ne jamais déplacer ou transporter une bouteille si son chapeau n'est pas en place.
- Ne jamais utiliser une bouteille de gaz ou son contenu à des fins autres que celles pour lesquelles elle est conçue.
- Ne jamais lubrifier le robinet des bouteilles avec de l'huile ou de la graisse.
- Éviter à tout prix le contact électrique entre l'arc plasma et une bouteille.
- Ne jamais exposer des bouteilles à une chaleur excessive, aux étincelles, aux scories ou aux flammes nues.
- Ne jamais utiliser des marteaux, des clés ou d'autres outils pour débloquer le robinet des bouteilles.

Détendeurs

- S'assurer que tous les détendeurs sont en état de marche.
- Ne jamais utiliser un détendeur avec un gaz autre que celui pour lequel il a été conçu.
- Ne jamais utiliser un détendeur qui fuit, présente une dérive excessive ou est endommagé.
- Ne jamais lubrifier un détendeur en utilisant de l'huile ou de la graisse.



AVERTISSEMENT — Détonation de l'hydrogène lors du coupage de l'aluminium

Quand on coupe l'aluminium sous l'eau, ou si l'eau touche la partie inférieure de la pièce d'aluminium, de l'hydrogène libre peut s'accumuler sous la pièce à couper et détoner lors du coupage plasma.

On peut éliminer la possibilité de détonation de l'hydrogène lors du coupage plasma de l'aluminium si l'on place un collecteur d'aération au fond de la table à eau. Voir l'annexe de ce manuel qui donne des directives pour fabriquer un collecteur d'aération.

Tuyaux

- Étiqueter et coder tous les tuyaux de gaz avec des couleurs différentes pour chaque type de gaz. Consulter les codes nationaux ou locaux applicables.
- Ne jamais utiliser un tuyau à oxygène pour un autre gaz.
- Examiner les tuyaux à intervalles réguliers pour vérifier s'ils présentent des fuites, s'ils sont usés ou si leurs raccords sont desserrés et s'ils présentent d'autres dangers.
- Remplacer un tuyau s'il est endommagé de quelque façon que ce soit.

Tuyaux (suite)

- N'utiliser que la longueur de tuyau nécessaire pour éviter les dégâts, réduire la chute de pression et éviter de réduire le débit.
- Empêcher la formation de coudes brusques en posant les tuyaux le plus possible en ligne droite entre les points de raccordement.
- Enrouler le tuyau en trop et le ranger pour ne pas l'endommager et pour éviter qu'il ne fasse trébucher.

Protection contre le bruit



Le coupage plasma peut être très bruyant. Selon le courant de l'arc, le matériau coupé, l'acoustique et la grandeur de la salle de coupage, l'éloignement de la torche et autres facteurs, votre système plasma peut dépasser les niveaux de bruit fixés par les codes nationaux et locaux.

- Porter en permanence un protecteur anti-bruit convenable quand on coupe ou gouge avec le système plasma.

Mise à la masse et à la terre

Alimentation

- S'assurer que le fil de terre du cordon d'alimentation est connecté à la terre dans le coffret du sectionneur.
- S'il faut brancher le cordon d'alimentation à la source de courant lors de l'installation du système, s'assurer que le fil de terre est correctement branché. Respecter les normes de l'Association canadienne de normalisation (ACNOR/CSA) en plaçant le fil de terre du cordon d'alimentation sur le plot de mise à la terre. Placer ensuite les autres fils de terre par-dessus. Bien serrer l'écrou de retenue.
- S'assurer que toutes les connexions sont bien serrées pour éviter la surchauffe.

Câble de retour

- Bien fixer le câble de retour (ou de masse) à la pièce à couper ou à la table de travail de façon à assurer un bon contact métal-métal.

Ne pas fixer le câble de retour à la partie de la pièce à couper qui doit se détacher.

Table de travail

- Raccorder la table de travail à terre, conformément aux codes de sécurité nationaux ou locaux appropriés.

Rappels de sécurité

- Ne jamais contourner ou court-circuiter les verrouillages de sécurité des systèmes plasma.
- Exception faite des plus gros systèmes mécanisés d'Hypertherm, toutes les torches Hypertherm sont conçues avec un verrouillage de sécurité qui empêche d'amorcer l'arc plasma quand la buse de protection est desserrée.
- Chaque système plasma Hypertherm n'est conçu que pour être utilisé avec les torches Hypertherm particulières. Ne pas les remplacer par d'autres torches qui pourraient surchauffer et présenter un danger pour l'opérateur et le personnel sur les lieux. La garantie d'Hypertherm ne couvre pas les dégâts causés par l'utilisation d'autres torches que celles d'Hypertherm.
- N'utiliser que les pièces consommables ou de rechange d'Hypertherm. La garantie d'Hypertherm ne couvre pas les problèmes causés par l'utilisation d'autres pièces que celles d'Hypertherm.
- Ne jamais faire fonctionner le système de coupage plasma si les capots ne sont pas en place, car cela mettrait en danger l'opérateur et les autres personnes présentes, en plus de compromettre le refroidissement des pièces.

Prothèses électroniques

Les systèmes de coupage et de gougeage plasma produisent des champs électriques et magnétiques qui peuvent créer des problèmes de fonctionnement pour les prothèses électroniques, comme les stimulateurs cardiaques et les appareils auditifs. Les personnes qui portent de telles prothèses doivent consulter un médecin avant de faire fonctionner un système plasma ou de s'en approcher, quand celui-ci est en marche. Pour réduire l'exposition aux champs électromagnétiques :

- Garder le câble de retour et le faisceau de la torche d'un côté du corps. Ne pas se tenir entre le faisceau de la torche et le câble de retour.
- Faire passer le faisceau de la torche le plus près possible du câble de retour.
- Ne pas entourer le faisceau de la torche ou le câble de retour autour du corps.
- Se tenir le plus loin possible de la source de courant.

Section 2 DESCRIPTION & SPECIFICATIONS

In this section:

General	2-2
Description of Equipment	2-3
Specifications	2-3
MAX43 Power Supplies (Non CE)	2-3
MAX400 CE 400V Power Supply	2-4
Gas Requirements	2-4
PAC125T Trigger Torch	2-5
PAC125M Machine Torch (Optional)	2-5
PAC121P Pushbutton Torch (Option for Non CE Systems Only)	2-5
IEC Symbols Used	2-6

DESCRIPTION & SPECIFICATIONS

GENERAL

Hypertherm's MAX43 plasma cutting systems are manufactured in non CE versions and a CE 400V, 3-phase, 50 Hz version (Figure 2-1). These systems are designed for hand cutting of most metals from gauge to 1/2- inch (13 mm) thick. An optional machine torch option is also available.

The MAX43 provides continuously variable current output from 20 to 40 amps on all thicknesses up to 1/2- inch (13 mm). This allows the operator wide variations in cutting speeds on the same thickness of metal. The 20-amp setting is for metals up to 1/16 inch (1.6 mm) thick, while the 40-amp setting is used for thicker metals.

MAX43 cut quality is superior and the parts life is longer compared to other plasma systems using air as the plasma gas. The inverter design provides smooth output DC voltage contributing to outstanding cut quality.

Air is used as the primary plasma gas, providing low operating costs combined with high-speed performance. Cylinder air or shop air can be used as long as it is free of moisture, oil and particulate matter contamination. For better cut quality on metals such as stainless steel and aluminum, nitrogen can be used as the plasma gas. A regulator and air filter are provided to ensure that the right pressure and air flow are supplied to the system at the proper quality.

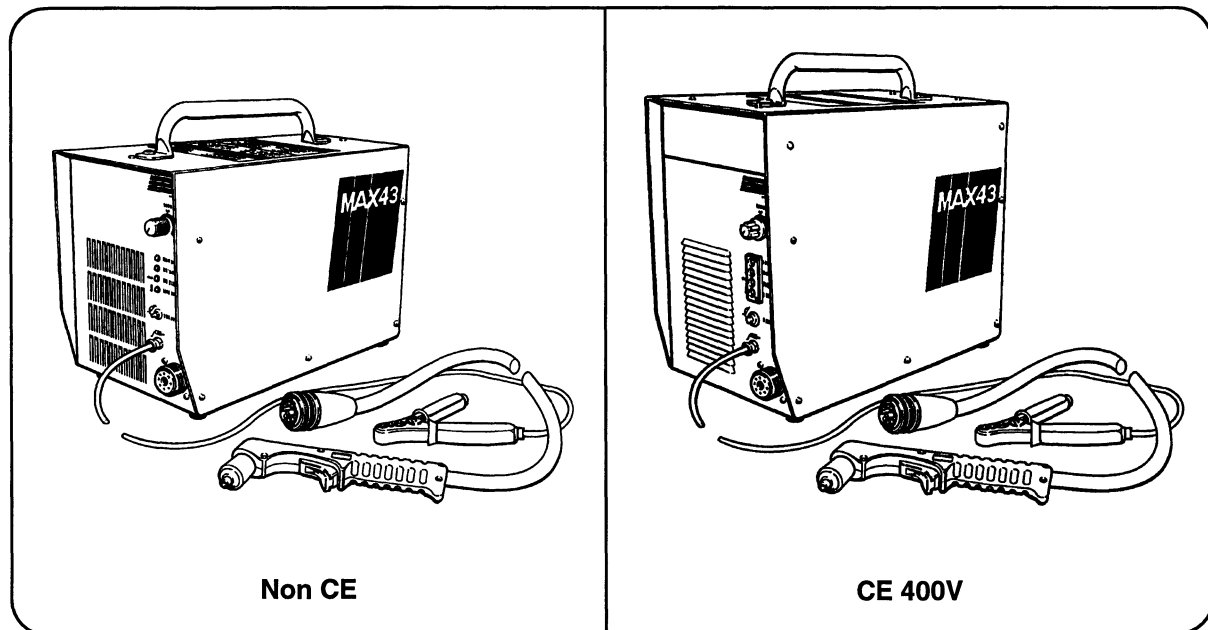

Figure 2-1 MAX43 Plasma Cutting Systems

DESCRIPTION & SPECIFICATIONS

DESCRIPTION OF EQUIPMENT

The MAX43 non CE and CE plasma cutting systems include a PAC125T torch with safety trigger; a torch lead; a work cable with clamp and a consumable parts kit. A PAC125M machine torch is also available for both non CE and CE systems. The machine torch is controlled by an optional on/off pendant. An optional PAC121P pushbutton torch optional machine interface assembly is also available for non CE systems.

SPECIFICATIONS

MAX43 Power Supplies (Non CE)

Maximum OCV (U_0)	300 VDC at rated input voltage
Rated output current (I_2)	40 amps (adjustable 20-40 amps)
Rated output voltage (U_2)	110 VDC
Duty cycle (X) at 40° C	50% at 40 amps 60% at 36 amps 100% at 28 amps
Ambient temperature/duty cycle	Power supplies will operate between +14° and 104° F (-10° and +40° C). Power supplies operated in an ambient temperature above 86° F (30° C) may show some decrease in duty cycle.
Input line voltage (U_1) and input line current (I_1)	
# 071044	208/240V, 1 Ph, 60 Hz, 38/33 amps
# 071055	400V, 3 Ph, 50 Hz, 11.7 amps
# 071054	480V, 3 Ph, 60 Hz, 9.8 amps
# 071082 (with machine interface)	208/240V, 1 Ph, 60 Hz, 38/33 amps
# 071083 (with machine interface)	400V, 3 Ph, 50 Hz, 11.7 amps
# 071084 (with machine interface)	480V, 3 Ph, 60 Hz, 9.8 amps
Dimensions:	
Width	9 -inches (229 mm)
Height	12 -inches (305 mm)
Depth	17 -inches (432 mm)
Weight	42 lbs. (19 kg) 48 lbs. (22 kg) w/25' (7.6m) leads

DESCRIPTION & SPECIFICATIONS

MAX43 CE 400V Power Supply

Maximum OCV (U_0)	300 VDC at rated input voltage
Rated output current (I_2)	40 amps (adjustable 20-40 amps)
Rated output voltage (U_2)	110 VDC
Cutting	
Duty cycle (X) at 40° C (at 110 arc volts)	35% at 40 amps 45% at 45 amps 60% at 31 amps 100% at 24 amps
Gouging	
Duty cycle (X) at 40° C (at 110 arc volts)	35% at 40 amps 60% at 31 amps 100% at 24 amps
Ambient temperature/duty cycle	Power supplies will operate between +14° and 104° F (-10° and +40° C). Power supplies operated in an ambient temperature above 86° F (30° C) may show some decrease in duty cycle.
Input line voltage (U_1) and input line current (I_1)	
# 071114	400V, 3 Ph, 50 Hz, 11.7 amps
Dimensions:	
Width	9 -inches (229 mm)
Height	15.25 -inches (388 mm)
Depth	17 -inches (432 mm)
Weight	56 lbs. (25.4 kg)

Gas Requirements

Gas Type	Shop compressed air, cylinder compressed air, or nitrogen (clean, dry, oil-free)
Shop compressed air	270 scfh (127 l/min) @ 80-120 psi (5.5-8.3 bar) supplied to power supply pressure regulator
Cylinder compressed air or nitrogen	270 scfh (127 l/min) @ 80 -120 psi (5.5-8.3 bar) supplied to power supply pressure regulator
Power supply pressure regulator setting	70 psig (4.8 bar) dynamic (flowing)

DESCRIPTION & SPECIFICATIONS

PAC125T Trigger Torch

Maximum cutting thickness range	1/2 inch (13 mm)
Gas Flow	270 scfh/4.5 scfm at 70 psi (127 l/min at 4.8 bar)
Weight	4.5 pounds (2 kg) with 25 ft. (7.6 m) lead

PAC125M Machine Torch (Optional)













Maximum cutting thickness range	1/2 inch (13 mm)
Gas Flow	270 scfh/4.5 scfm at 70 psi (127 l/min at 4.8 bar)
Weight	7 pounds (3.2 kg) with 25 ft. (7.6 m) lead

PAC121P Pushbutton Torch (Option for Non CE Systems Only)

Maximum cutting thickness range	1/2 inch (13 mm)
Gas Flow	270 scfh/4.5 scfm at 70 psi (127 l/min at 4.8 bar)
Weight	6 pounds (2.7 kg) with 25 ft. (7.6 m) lead

DESCRIPTION & SPECIFICATIONS

IEC SYMBOLS USED

	Direct Current (DC).
	Alternating current (AC).
	Plasma cutting torch.
	AC input power connection.
	The terminal for the external protective (earthed) conductor.
	An inverter-based power source.
	Anode (+) work clamp.
	Temperature switch.
	Pressure switch.
	Plasma torch in the TEST position (cooling and cutting gas exiting nozzle).
	The power is on.
	The power is off.
	Volt/amp curve.

Section 3 SETUP

In this section:

Upon Receipt	3-2
208-Volt Operation	3-2
Power Requirements	3-3
Non CE Power Supplies	3-3
CE 400V Power Supply	3-3
Power Cord	3-3
Non CE 400V and 480V Power Supplies	3-3
CE 400V Power Supply	3-3
Grounding	3-3
Work Cable	3-4
Torch Lead Connection	3-4
PAC125M On/Off Pendant Connection	3-4
PAC125M Torch On/Off Switch Connection Data	3-5
Machine Interface Cable and Signal Data (Non CE Units Only)	3-5
Torch Alignment	3-5
Gas Supply Requirements	3-6
Shop Compressed Air	3-6
Cylinder Compressed Air	3-6
Nitrogen	3-6

SETUP

UPON RECEIPT

1. Remove the unit and save the carton. The carton is reusable and provides an impact-resistant box for transporting or storing the unit.

The carton should include:

- MAX43 Power Supply or MAX43 CE 400V Power Supply
- PAC125T Torch and Lead
- Consumable Parts Kit
- Instruction Manual 801290 (IM-129)

Options:

- PAC125M Machine Torch
- PAC125M Torch On/Off Pendant
- PAC121P Pushbutton Torch (non CE units only)

2. Verify that all parts and items are included. Alert your distributor if any parts or items are missing.
3. Inspect the power supply for any physical damage that may have occurred during shipping. If there is evidence of damage, see the *Claims* section for instructions.

Before operating the MAX43, read the *Safety* and *Operation* sections of this manual.

208-VOLT OPERATION

The MAX43 has no linkboard, but a simple movement of a wire on the control transformer is necessary to run the unit on 208 volts. To run the unit at 208 volts, move wire labeled 11 from terminal point 5 to terminal point 3. Refer to Figure 3-1 to make the change.

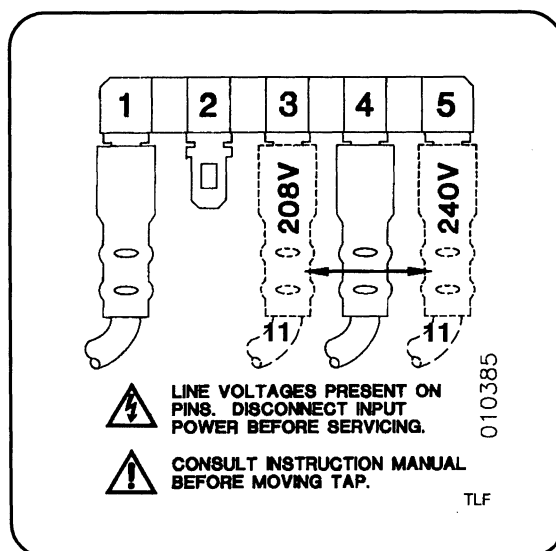

Figure 3-1
208-Volt Operation

POWER REQUIREMENTS

- Use a primary line disconnect switch for each power supply. This switch allows the operator to turn the power supply off quickly in an emergency situation. The switch should be located on a wall near the power supply, and should be easily accessible to the operator. The interrupt level of the switch must be equal to or exceed the continuous rating of the fuses.
- Use fuses (class K5) according to the power requirements listed below.

Non CE Power Supplies

<u>Input Voltage Range</u>	<u>Phase</u>	<u>Input Current Range @ 4.4 kw Output</u>	<u>Recommended Fuse Size</u>
208-240 VAC	1	38-33 amps	50 amps
400 VAC	3	11.7 amps	15 amps
480 VAC	3	9.8 amps	15 amps

CE 400V Power Supply

<u>Input Voltage Range</u>	<u>Phase</u>	<u>Input Current Range @ 4.4 kw Output</u>	<u>Recommended Fuse Size</u>
400 VAC	3	11.7 amps	15 amps

POWER CORD

Non CE 400V AND 480V Power Supplies

- The MAX43, 400V (# 071055) and 480V (# 071054) power supplies are shipped without the plug connected to the power cord. The user must obtain a plug that is certified by national and local electrical codes. The plug should be connected to the power cord by a licensed electrician.

CE 400V Power Supply

- The MAX43 CE 400V power supply (# 071114) is shipped without the plug connected to shielded power cord. Refer to the Appendix for power cord information so that a compatible power cord and plug can be obtained that is certified by national and local electrical codes.

GROUNDING

To ensure personal safety and to reduce emission of radio frequency interference, the power unit must be properly grounded:

- The power supply must be properly grounded through the power cord according to your local electric power company requirements. The MAX43 cabinet is electrically conductive and can present a shock hazard if it is not properly grounded through the line disconnect switch. The service must be of the 3-wire type with a green/yellow wire protective "Earth Ground." It must

SETUP

comply with local electrical requirements. Do not use a 2-wire service. Refer to *Grounding* in the *Safety* section.

- For more information, refer to Standards Index, Section 7 for other appropriate electrical codes.

WORK CABLE

- Attach the system work clamp to the workpiece or to the work table. Make sure that the work clamp and the workpiece or work table make good metal-to-metal contact.
- Do not attach the work clamp to the portion of the workpiece being cut away (see Fig. 3-2).

Figure 3-2
**Proper Work
Clamp Connection**

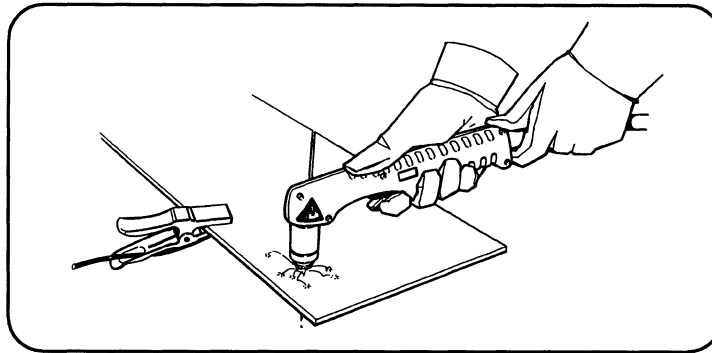

TORCH LEAD CONNECTION

To connect the torch lead to the power supply:

- Align the connector plug key (on torch lead) with the connector receptacle key slot (on power supply) and push in until pins seat.
- Turn the connector securing ring 1/4 turn counter-clockwise (ccw) to ensure that the securing ring threads and the connector receptacle threads are aligned prior to tightening.

Caution: The connector is fine-threaded. Cross threading can easily occur which could cause thread damage.

- Turn the connector securing ring clockwise (cw) to tighten.

PAC125M ON/OFF PENDANT CONNECTION

To connect the optional on/off pendant lead to the PAC125M machine torch lead pigtail, proceed as follows:

- Align the pendant lead connector plug key with the connector receptacle key slot on the pigtail and push in until pins seat.
- Turn the connector securing ring clockwise (cw) to tighten.

PAC125M TORCH ON/OFF SWITCH CONNECTION DATA

The PAC125M torch lead is supplied with a pigtail so that the optional on/off pendant (028714, 128061 or 128062) may be used. If you want to use a different on/off switch configuration, note that the wiring configuration to the 3-pin male plug on the pigtail is as follows:

Pin A	White Wire
Pin C	Black Wire
Pin B	Not Used

MACHINE INTERFACE CABLE AND SIGNAL DATA (Non CE Units Only)

The optional machine interface assembly requires a customer supplied interface cable. The cable wiring should be 22 AWG, 3 pair, individually twisted, shielded, 300 volt certified UL/CSA wire (example Belden 8767). Use Weidmuller wire tip, insulated ferrules # 4095.0 to connect the interface cable to TB1 on the machine interface assembly.

The machine interface signals are as follows:

Machine Interface Signals at TB1	Description
ARC TRANS	Output 120 VAC maximum (dry contact) — Starts machine motion
ARC TRANS	Output 120 VAC maximum (dry contact) — Starts machine motion
⊖ ARC	Output 300 VDC maximum (open circuit voltage) — Torch height control (full arc voltage - no voltage divider)
⊕ ARC	Output 300 VDC maximum (open circuit voltage) — Torch height control (full arc voltage - no voltage divider)
START	Input 24 VAC open circuit, close contacts to start (dry contact) — Starts plasma
START	Input 24 VAC open circuit, close contacts to start (dry contact) — Starts plasma

TORCH ALIGNMENT

Before cutting with the PAC125M torch, ensure that the torch is mounted at right angles to the workpiece to get a clean, vertical cut. Use a square to align the torch.

SETUP

GAS SUPPLY REQUIREMENTS

The gas supply for the MAX43 can be either air or nitrogen. Air can be supplied as shop compressed air or cylinder compressed air. Nitrogen can be supplied from compressed gas cylinders or liquid containers. All oil, moisture and other contaminants must be removed. Use an inert gas hose to connect the gas supply to the input connection on the pressure regulator mounted on the rear of the power supply. A minimum of 80 psi (5.5 bar) must be supplied to the pressure regulator.

Caution: The MAX43 pressure regulator is rated at a maximum of 150 psi (10.3 bar) at the input. Do not set the air or nitrogen cylinder regulator to a pressure greater than 150 psi (10.3 bar).

Shop Compressed Air

Clean, dry, oil-free shop air can be used to supply the MAX43. Shop air must be available at a minimum pressure of 80 psi (5.5 bar) and must be routed through the regulator and filter supplied with the system. The regulator and filter are mounted at the top rear of the MAX43 power supply.

Cylinder Compressed Air

The cylinder air supply must be clean, dry and oil-free. The regulator must be used only for compressed air and must be capable of delivering at least 270 scfh/4.5 scfm (127 l/min) of air at 80 psi (5.5 bar) output pressure.

Caution: The regulator supplied with the system must be used in conjunction with the regulator on the air cylinder. The pressure from the cylinder must not be allowed to exceed the pressure limit of the MAX43. Do not set the cylinder regulator to a pressure greater than 150 psi (10.3 bar).

Nitrogen

To use nitrogen as the plasma gas, it must be supplied to the MAX43 at 99.995% purity. The nitrogen source can be compressed gas cylinders or liquid containers. It must be capable of delivering a minimum of 270 scfh/4.5 scfm (127 l/min) at a delivery pressure of 80 psi (5.5 bar).

If the purity level of the nitrogen is too low, cut speeds decrease, cut quality deteriorates, cutting thickness capability decreases, and parts life shortens. (Note: These conditions also occur if there are leaks in the gas supply hoses or connections.)

Caution: The regulator supplied with the system must be used in conjunction with the regulator on the nitrogen cylinder. The pressure from the cylinder must not be allowed to exceed the pressure limit of the MAX43. Do not set the cylinder regulator to a pressure greater than 150 psi (10.3 bar).

Section 4 OPERATION

In this section:

Front Panel Controls	4-2
Rear Panel Controls	4-3
Operating Instructions	4-4
Operating Tips	4-6
Changing Consumable Parts	4-6
PAC125T Safety Trigger Operation	4-7
Cutting	4-8
Piercing	4-10
Gouging	4-10
Common Cutting Faults	4-12
Duty Cycle	4-12
Gas Pressure	4-12
Torch Heat	4-12
Claims and Technical Questions	4-12
Operating Data Chart	4-13

OPERATION

FRONT PANEL CONTROLS

- **AMPS output adjustment knob**
Adjusts output current infinitely between 20 and 40 amps.
- **Green POWER ON LED**
Illuminates when all control circuits are activated, the torch safety interlock is satisfied, and the system is ready for operation.
- **Green LINE VOLTAGE LED**
Illuminates when the AC line voltage is satisfactory.
- **Green GAS PRESSURE LED**
Illuminates when the pressure is within operating limits.
- **Yellow OVER TEMPERATURE LED**
Remains extinguished when the power supply temperature is within operating limits.
- **GAS TEST Switch**
Allows the operator to view and adjust pressure setting (if required) when pushed in.

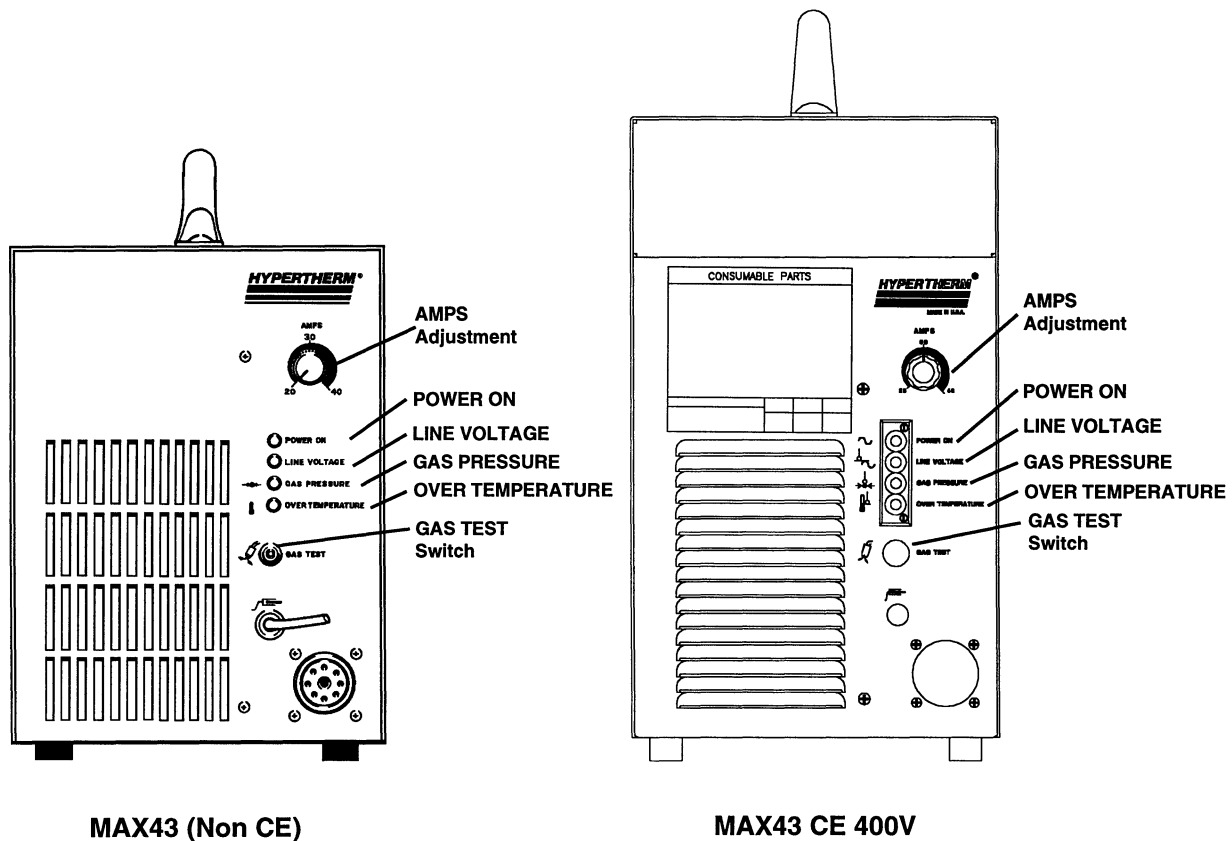

Figure 4-1 Front Panel Controls

REAR PANEL CONTROLS

- **ON (I)/OFF (0) Power Switch**
Activates the power supply and its control circuits.
- **Pressure Regulator**
Regulates input gas pressure to power supply.

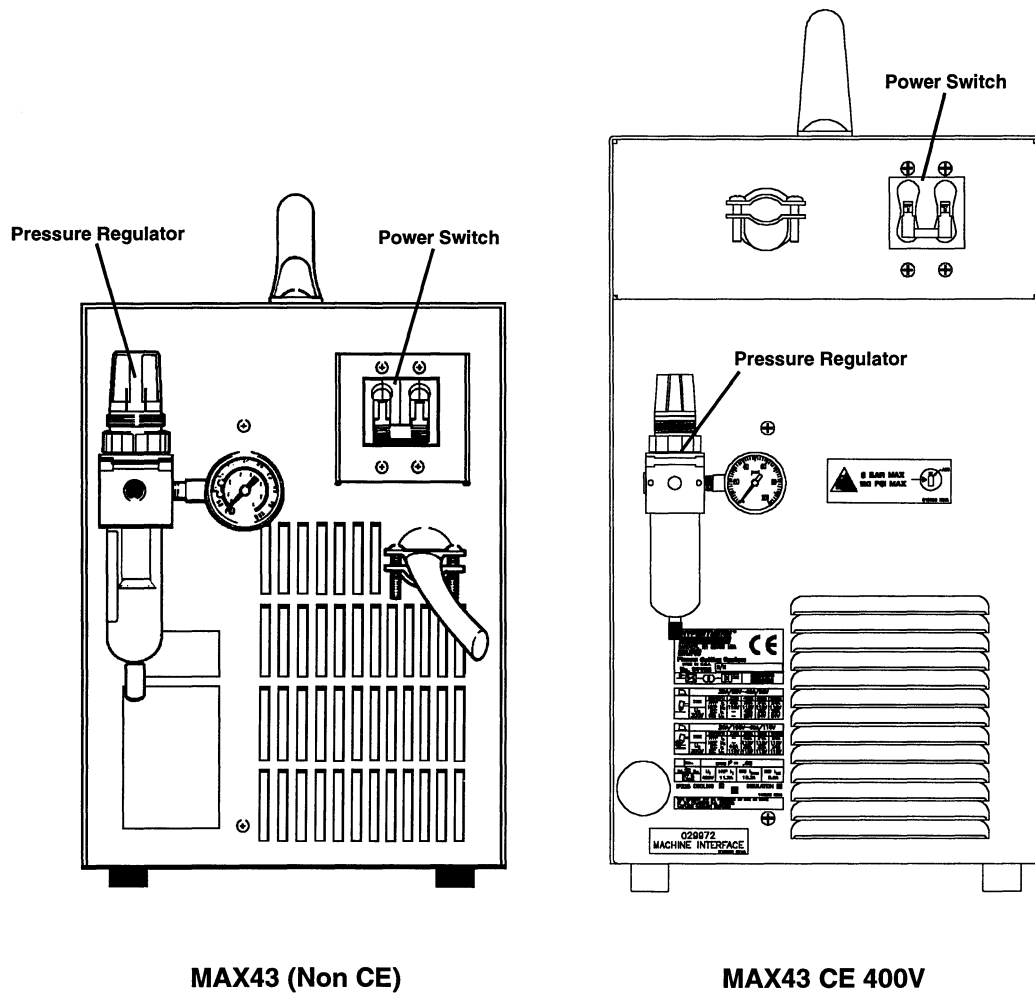

Figure 4-2 Rear Panel Controls

OPERATION

OPERATING INSTRUCTIONS

1. Ensure that the work environment and your clothing meet the safety requirements outlined in the *Safety* section.
2. Follow the instructions in the *Setup* section.
3. Using a quick connect air fitting, attach the compressed air or nitrogen to the male fitting on the pressure regulator.
4. Set the power switch to the ON (I) position. The POWER ON, LINE VOLTAGE, and GAS PRESSURE LEDs should light. The OVER TEMPERATURE LED should remain off.
5. Push the GAS TEST switch while checking the filter/pressure regulator gauge for a reading of 70 psi (4.8 bar). If the reading is incorrect adjust the pressure regulator as follows (see Figure 4-3).
 - Ensure the gas supply is at 80-120 psi (5.5-8.3) bar with at least 270 scfh/4.5 scfm (127 l/min) flow capacity.
 - At the pressure regulator, pull the the adjustment cap up to loosen.
 - At the front panel, push the **GAS TEST** switch in and hold and view pressure gauge while adjusting the pressure regulator cap. Adjust until the pressure gauge reads 70 psi (4.8 bar).
 - Release **GAS TEST** switch and push the adjustment cap down to secure.
6. Look for moisture coming out of the torch. If there is moisture, purge the lines. The filter bowl is drained at the bottom by removing the red cap and turning the knurled drain valve. If the bowl doesn't drain properly, clean the bowl or clean or replace the filter by the following procedure:
 - Always **shut the gas supply off and disconnect** the gas supply hose from the pressure regulator before unscrewing the filter bowl.
 - Unscrew the filter bowl and then remove the filter and clean or replace if required.
 - Replace the filter and filter bowl.
 - Reconnect the gas supply hose.
7. Attach the work clamp securely to the workpiece. **Do not attach it to the portion that will fall away (see Figure 4-4).**
8. To ensure optimum cutting, refer to the *Operating Data Chart* at the end of this section.



WARNING



The pilot arc starts immediately (no preflow) when the torch switch is pressed.

OPERATION

9. The unit is now ready to operate. When you are ready to cut, place the torch on the workpiece. Press the torch switch to start arc.
10. The arc transfers from the torch to the workpiece. Move the torch in the desired direction, at a speed which will ensure good cut quality.
11. When the cut is finished, release the torch switch to stop the arc.

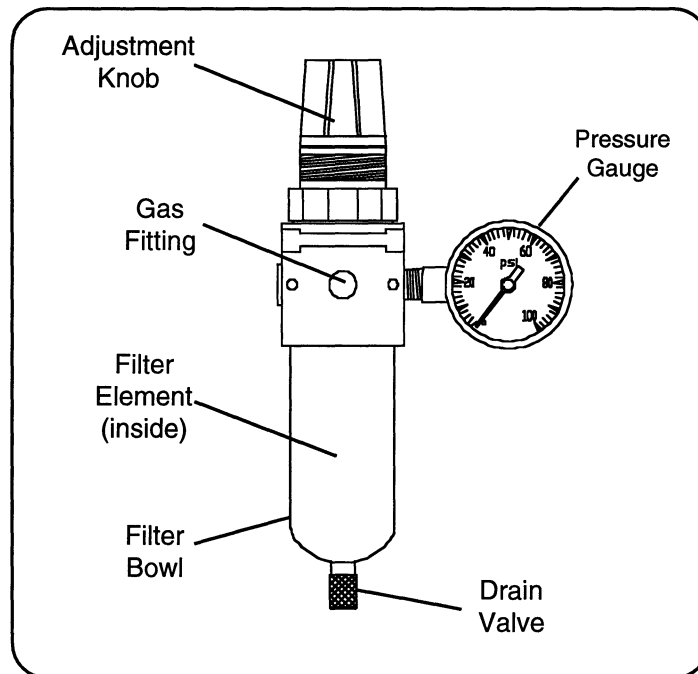

Figure 4-3 Pressure Regulator Components

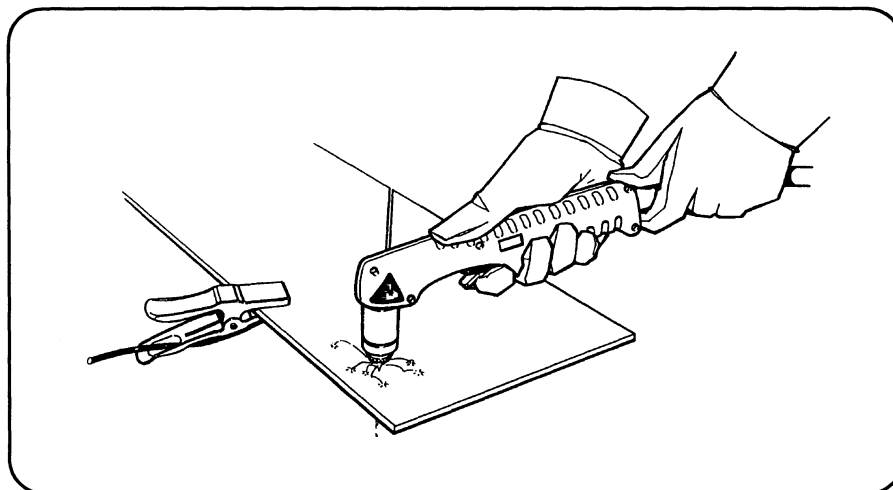



Figure 4-4 Proper Work Clamp Connection

OPERATION

OPERATING TIPS

Changing Consumable Parts



WARNING



Always unplug the power supply before inspecting or changing the torch parts.

Do not use the cap on sensor switch to remove power from the power supply by causing circuit breaker S1 to trip off when the retaining cap is removed with the power on. Do not rely on the cap on sensor switch to remove power. It is provided strictly for safety backup.

Inspect the nozzle for damage or wear. If the hole in the nozzle is worn or oval-shaped, it is time to change it. Inspect the electrode. If the center of the electrode has a pit more than 1/16 inch (1.6 mm) deep, replace it.

Changing the consumable parts requires no tools. Unplug the power supply. Unscrew the retaining cap and the remaining parts will come apart easily. When you unscrew the retaining cap, you'll hear a click. This click is a microswitch disabling the power supply (if it has not been unplugged) so that the torch cannot accidentally be activated. Replace the parts per Figures 4-5 and 4-6. Each part fits in only one direction, so you cannot put the parts in backwards. Also, the torch will not fire if the parts are improperly assembled.

When the nozzle, electrode and swirl ring are properly in place, replace the retaining cap. When the retaining cap is tightened, the microswitch will click, indicating that the torch is operable again. Plug the power supply back in.

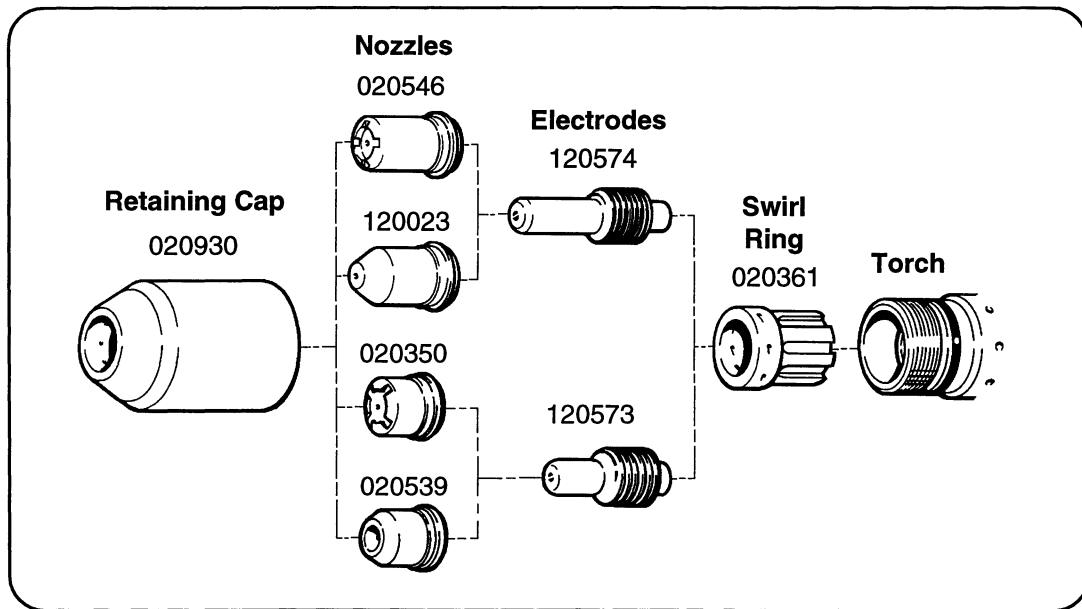

Figure 4-5 Unshielded Consumable Parts

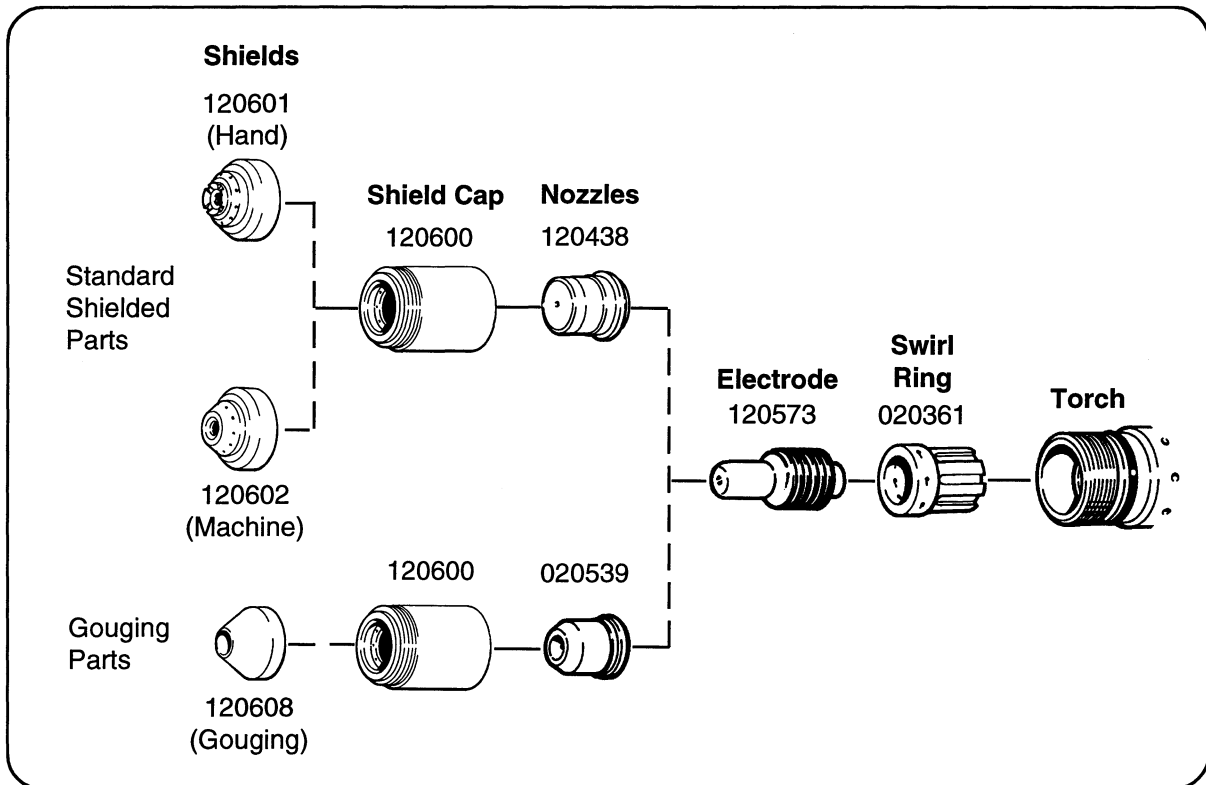



Figure 4-6 Shielded Consumable Parts

PAC125T Safety Trigger Operation

The PAC125T safety trigger torch allows operators the ability to safely handle the torch before and after the cut and to minimize the possibility of accidental torch firing. The safety trigger is easy to operate. Follow the steps in Figure 4-7.



WARNING



The hand-held torches and machine torch are instant-on torches. These torches fire (produce a plasma arc) immediately after torch switch closure or remote switch closure for a machine torch. Always hold the hand torch away from your body as a precaution against accidental torch firing. Be aware of this hazardous potential, failure to do so can result in serious bodily injury.

OPERATION

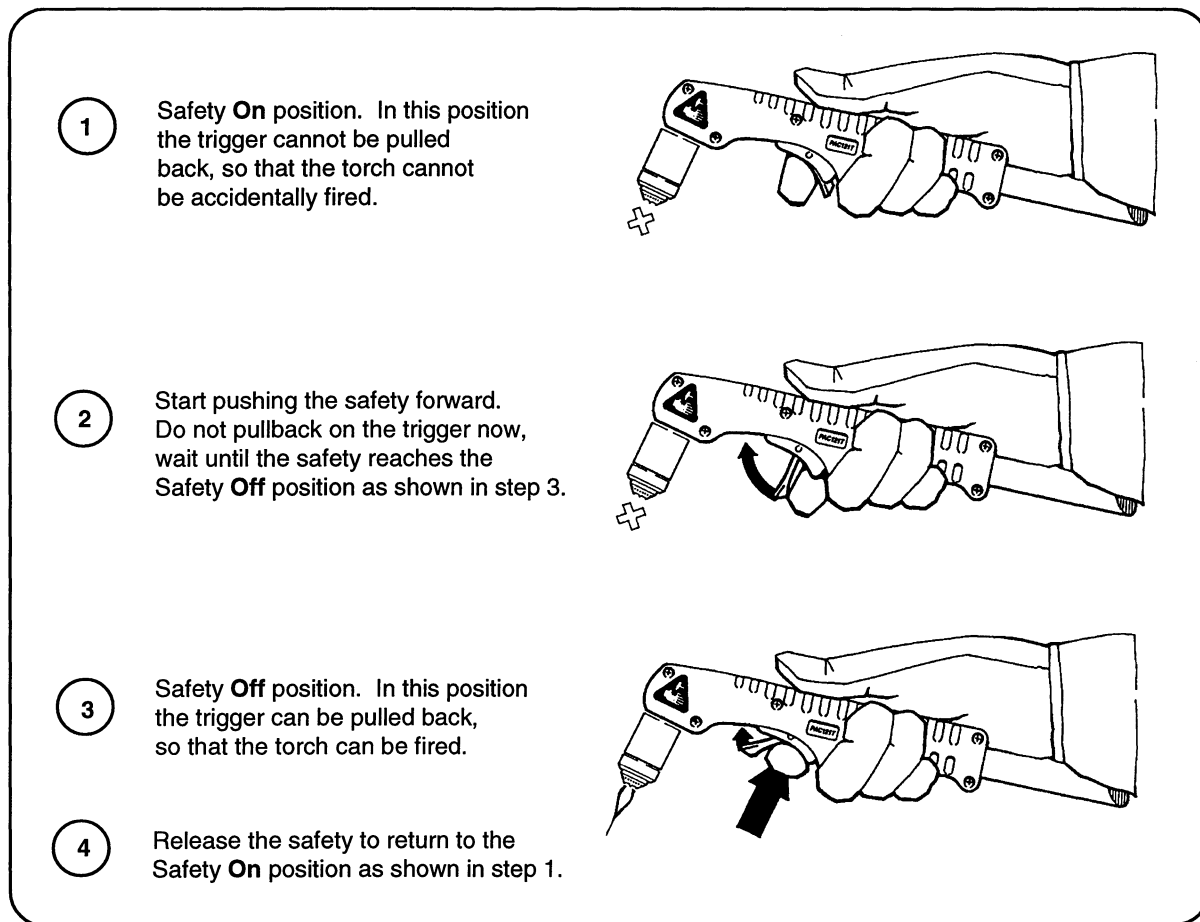

Figure 4-7 PAC125T Torch Safety Trigger Operation

Cutting

- Do not fire the pilot arc into the air needlessly—doing so causes a significant reduction of the nozzle and electrode life.
- If arc transfer does not occur within three seconds, the pilot arc will stop. Release the torch start button and press it again to reset the pilot arc timer.
- Start cutting from the edge of the workpiece (Figure 4-8)
- When cutting, make sure that the sparks are coming out of the bottom of the workpiece. If they are spraying on top of the workpiece, you are moving the torch too fast, or you do not have sufficient power to fully penetrate the workpiece.
- Hold the torch lightly on the metal or just off the metal. Holding the torch firmly to the workpiece causes the nozzle to stick and makes smooth cutting difficult. The arc transfers to the workpiece once the torch is within 1/8 inch of the workpiece.

OPERATION

- To cut perfect circles for spin fittings, use a template or a radius cutter attachment (Figure 4-9).
- Pull the torch through the cut. Pulling it is easier than pushing it.
- Hold the torch nozzle at a vertical position and watch the arc as it cuts along the line (Figure 4-10). By lightly dragging the nozzle on the workpiece, you can maintain a steady cut. For straight-line cuts, use any straight edge as a guide.
- When cutting thin material, reduce the amps until you get the best quality cut.

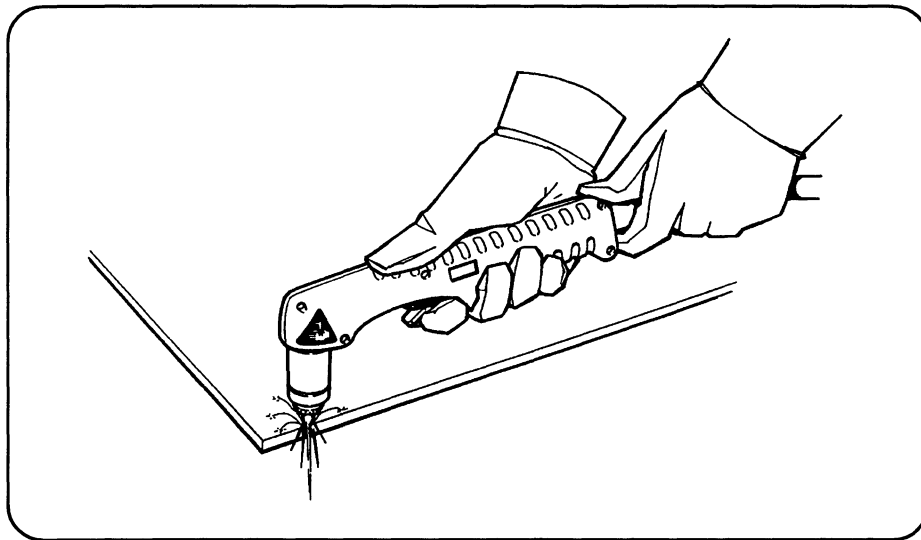

Figure 4-8 Starting a Cut

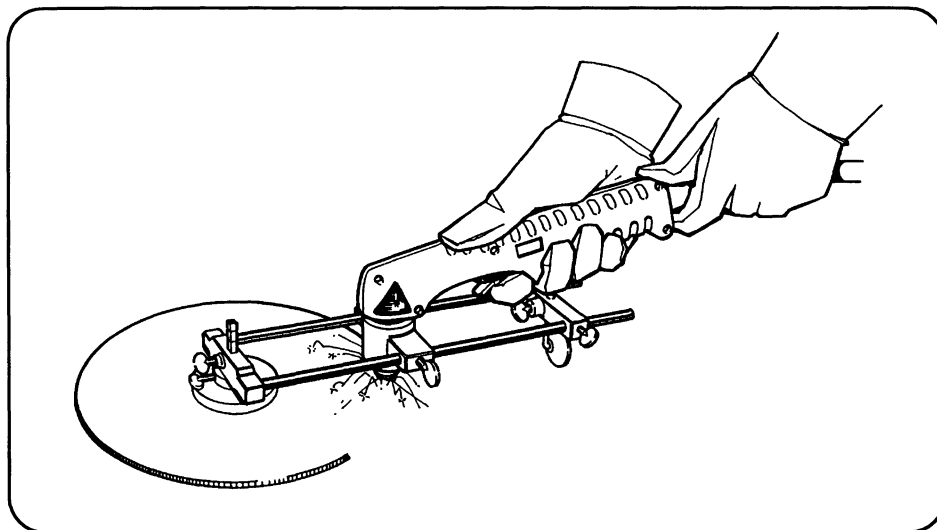

Figure 4-9 Cutting a Circle

OPERATION

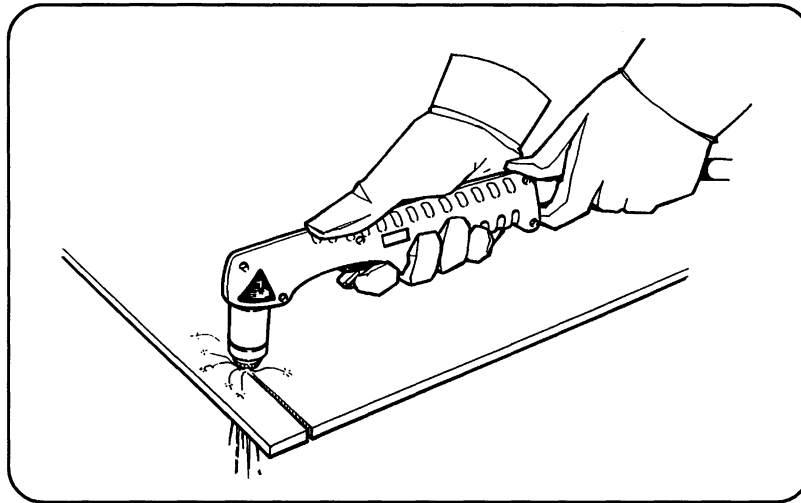

Figure 4-10 Dragging the Torch

Piercing

- Hold the torch so that the nozzle is approximately 1/16 inch (1.6 mm) away from the workpiece before firing the torch. This method maximizes the life of the nozzle.
- Hold the torch at an angle to the workpiece away from yourself, then slowly roll it to a vertical position. (This is particularly important when cutting thicker material.) Make sure that the torch is pointed away from you and the people around you to avoid any danger from sparks and hot metal.
- Start the cut at an angle rather than in an upright position. This method permits the hot metal to escape to one side rather than splashing back against the nozzle, protecting the operator from the sparks and extending the life of the nozzle (Figure 4-11).
- When the pierce is complete, proceed with the cut.

Gouging

The MAX43 can be used for gouging mild steel by using the gouging nozzle. To gouge:

- Always wear full protection:
 - A welding helmet with at least a #6 glass
 - Welding gloves
 - A welding jacket.

The arc is fully exposed and will cause serious burns if the skin is not covered.

- Install the gouging nozzle just as you would install a standard cutting nozzle.
- Adjust the air pressure to 50-55 psi (3.4-3.8 bar) with air flowing from the torch. Note that this is slightly lower than the cutting pressure.

OPERATION

- Tilt the torch approximately 45° from the surface to be gouged and feed into the gouge. Try not to allow the nozzle to come into contact with the workpiece since this can cause premature wear of the nozzle. Multiple passes or "wearing" may be necessary to gouge wider and deeper sections (Figure 4-12).

Figure 4-11
Piercing

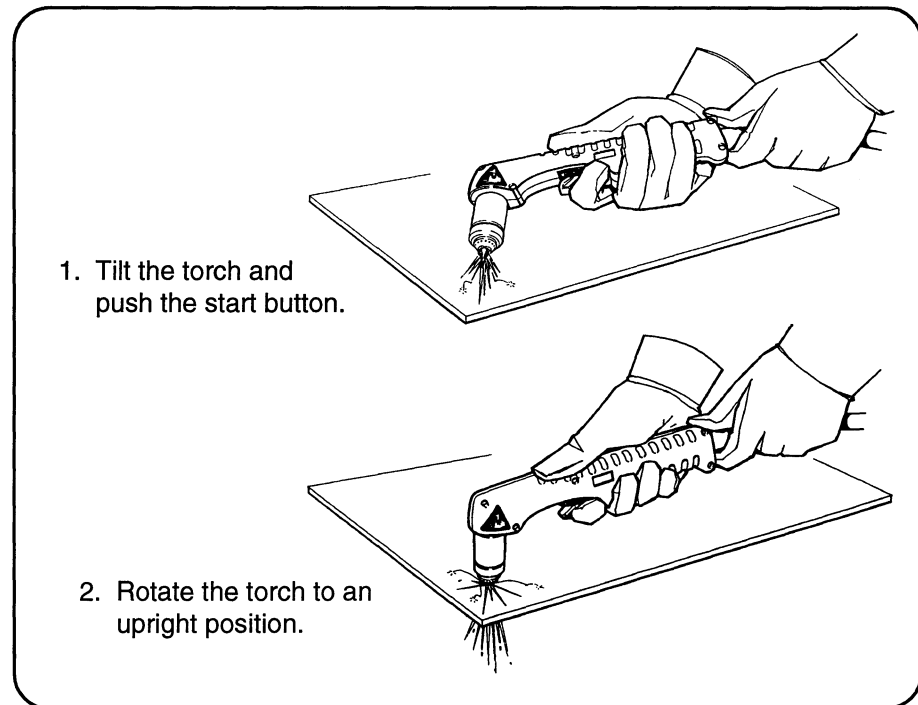
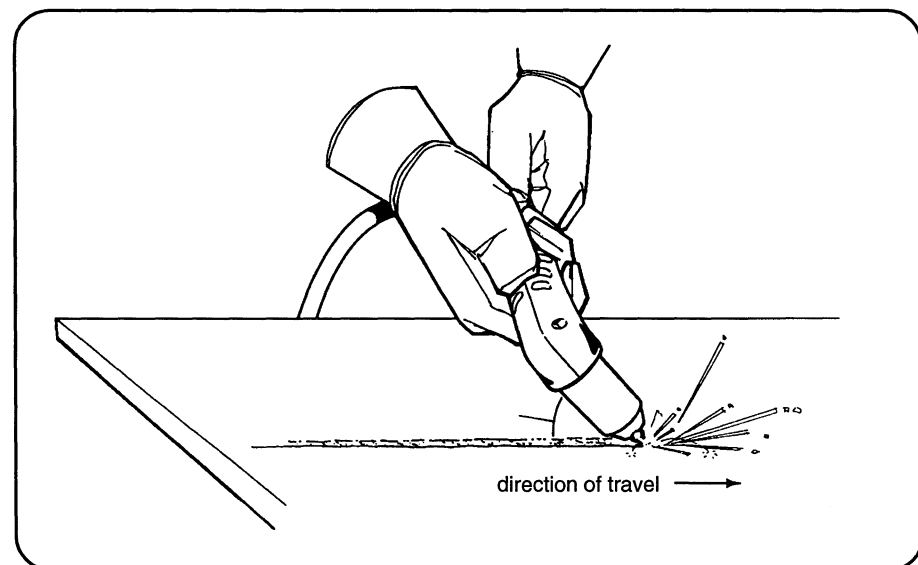

Figure 4-12
Gouging



OPERATION

Common Cutting Faults

- The workpiece is not totally penetrated. Causes can be:
 - The current is too low.
 - The cut speed is too high.
 - The torch parts are worn.
 - The metal being cut is too thick.
- Dross forms on the bottom of the cut. Causes can be:
 - The cutting speed is too slow.
 - The torch parts are worn.
 - The metal being cut is too thick.
 - The current is too low.

Duty Cycle

The duty cycle, or the amount of time the pilot or plasma arc can remain “on” in minutes within a 10-minute period, is affected by many factors. For example, on a non CE unit when the current is set at 40 amps, the MAX43 has a 50% duty cycle at a temperature of 40° C. During normal operation, the plasma arc can remain on 5 minutes out of every 10 minutes without causing the temperature sensors to disable the unit. The duty cycle increases to 100% at a temperature of 40° C when the current is set at 28 amps.

Gas Pressure

Compressed air or nitrogen must be available to the power supply filter/pressure regulator at a flow rate of 270 scfh/4.5 scfm (127 l/min) and a pressure of 70 psi (4.8 bar). If the pressure to the power supply is below 40 psi, the torch goes out.

Torch Heat

After several minutes of running, the torch retaining cap may become hot. To cool it, push the GAS TEST switch in and hold until the cap cools down.

CLAIMS AND TECHNICAL QUESTIONS

Claims for defective merchandise — All units shipped from Hypertherm undergo rigorous quality control testing. However, if your unit does not function correctly:

1. Read the *Maintenance* section of this manual. You may find the problem is quite easy to fix, such as a loose connection.
2. If you are unable to solve the problem, call your distributor. He will be able to help you, or refer you to an authorized Hypertherm repair facility.
3. If you need assistance, call Customer Service or Technical Service at the numbers listed in the front of this manual.

OPERATING DATA CHART

<u>Thickness</u>	<u>Material</u>	<u>Current</u>	<u>Travel Speed</u>
26 ga. (.477 mm)	Mild/galvanized steel	20 amps	180 ipm (4572 mm/min)
24 ga. (.635 mm)	Mild/galvanized steel	30 amps	280 ipm (7112 mm/min)
18 ga. (1.27 mm)	Mild/galvanized steel	30 amps	200 ipm (5080 mm/min)
1/16 in. (1.5 mm)	Mild/galvanized steel	40 amps	180 ipm (4572 mm/min)
1/8 in. (3 mm)	Mild steel	40 amps	110 ipm (2794 mm/min)
1/4 in. (6 mm)	Mild steel	40 amps	35 ipm (889 mm/min)
3/8 in. (10 mm)	Mild steel	40 amps	15 ipm (381 mm/min)
1/2 in. (13 mm)	Mild steel	40 amps	10 ipm (254 mm/min)
28 ga. (.396 mm)	Stainless steel	40 amps	250 ipm (6350 mm/min)
24 ga. (.635 mm)	Stainless steel	40 amps	200 ipm (5080 mm/min)
1/16 in. (1.5 mm)	Stainless steel	40 amps	125 ipm (3175 mm/min)
1/8 in. (3 mm)	Stainless steel	40 amps	60 ipm (1524 mm/min)
1/4 in. (6 mm)	Stainless steel	40 amps	22 ipm (559 mm/min)
3/8 in. (10 mm)	Stainless steel	40 amps	12 ipm (305 mm/min)
1/2 in. (13 mm)	Stainless steel	40 amps	9 ipm (229 mm/min)
1/32 in. (.800 mm)	Aluminum	40 amps	400 ipm (10160 mm/min)
1/16 in. (1.5 mm)	Aluminum	40 amps	200 ipm (5080 mm/min)
3/32 in. (2.4 mm)	Aluminum	40 amps	120 ipm (3048 mm/min)
1/8 in. (3 mm)	Aluminum	40 amps	100 ipm (2540 mm/min)
1/4 in. (6 mm)	Aluminum	40 amps	30 ipm (762 mm/min)
3/8 in. (10 mm)	Aluminum	40 amps	13 ipm (330 mm/min)
1/2 in. (13 mm)	Aluminum	40 amps	8 ipm (203 mm/min)

Section 5 MAINTENANCE

In this section:

General	5-2
Power Supply	5-2
Torch and Torch Leads	5-2
Sequence of Operation	5-3
Problems and Solutions	5-4
PAC125T Torch Parts Removal and Replacement	5-6
Torch Main Body Removal and Replacement	5-6
Torch Switch Removal and Replacement	5-7
PAC121P Torch Parts Removal and Replacement	5-8
Torch Main Body Removal and Replacement	5-8
Torch Switch Removal and Replacement	5-8
PAC125M Torch Parts Removal and Replacement	5-10
Removal	5-10
Replacement	5-11
Quick Disconnect O-Ring Removal and Replacement	5-12

MAINTENANCE

GENERAL

The MAX43 is designed to require little maintenance under normal use and conditions. The routine maintenance suggestions in this section will allow the MAX43 operator to keep the system in peak operating condition.

The information provided in this manual is for operator level maintenance only. Do not remove the power supply cove under any conditions to perform maintenance. Contact a qualified service technician and refer to the MAX43 Service Manual IM-168 (801680).



WARNING



SHOCK HAZARD: Do not remove the cover for servicing within the power supply. Dangerous voltages exist within the power supply which could cause serious injury or death. Contact a qualified service technician if servicing is required. If questions or problems arise about servicing, call the Hypertherm Technical Service number listed in the front of this annual.

Power Supply

Inspect the power supply on a regular basis:

- Check the exterior for any damage that might affect the safe operation of the power supply.
- Inspect the filter bowl and filter element of the filter/ regulator unit at the rear of the power supply. Refer to *Problems and Solutions* in this section for filter bowl cleaning and filter element replacement.
- Inspect the power supply air filter. **Refer to MAX43 Service Manual IM-168 (801680). Only qualified technicians aware of electrical safety precautions should access the power supply interior for cleaning or maintenance.**
- Inspect the power supply interior. **Refer to MAX43 Service Manual IM-168 (801680). Only qualified technicians aware of electrical safety precautions should access the power supply interior for cleaning or maintenance.**

Torch and Torch Leads

- Inspect the torch and torch leads for physical damage on a regular basis.

Check the torch main body and consumable parts. Refer to *Changing Consumable Parts* in Section 4, *Operation*.

Refer to the hand and machine torch and torch leads removal and replacement procedures in this section.

SEQUENCE OF OPERATION

The sequence of operation provides the operator the way the MAX43 system should normally operate. If it does not operate an approximate manner, refer to problems and solutions in this section. If the problem requires detailed troubleshooting which requires removing the the power supply cover, contact a qualified service technician and refer to the MAX43 Service Manual IM-168 (801680).

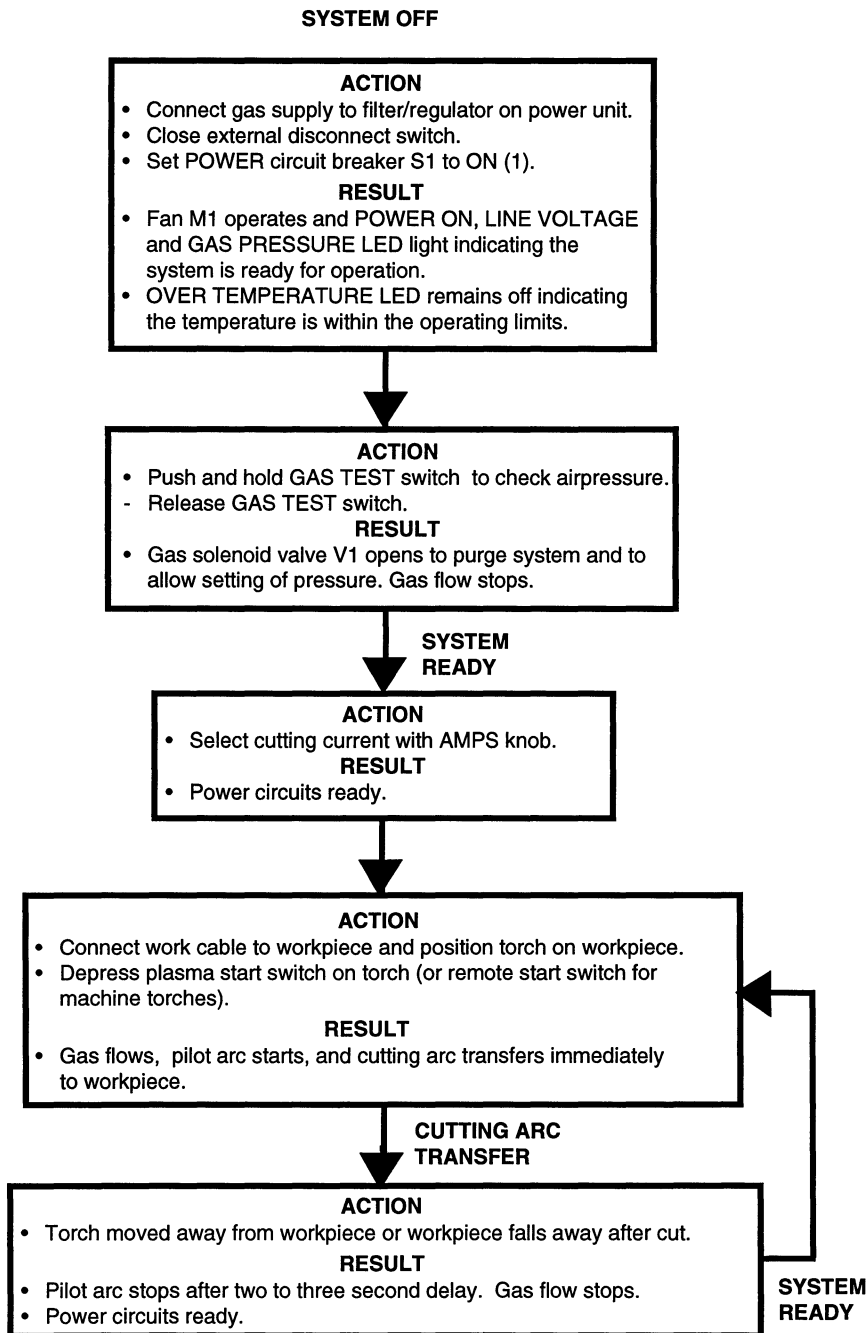

MAINTENANCE

PROBLEMS AND SOLUTIONS

The following problems and solutions provide basic troubleshooting for the operator. If the power supply requires more in depth troubleshooting, refer to the MAX43 Service Manual IM-168 (801680). A technician with a working knowledge of inverter power supply theory is required.

Problem: The POWER circuit breaker is set to I (on), but the fan does not operate. The green POWER ON LED is not lit.

Cause: The disconnect power switch is not set to on or there is no power available to the disconnect power switch box.

Solution: Turn the power on at the main power panel or at the disconnect power switch box.

Problem: The POWER circuit breaker is set to I (on), the fan operates, but the green POWER ON LED is not lit.

Cause: One or more of the green status LEDs does not illuminate or the yellow LED illuminates.

Solution: Check the problem associated with status LED.

Problem: The circuit breaker on the incoming power line fails during cutting, or the Power on/off circuit breaker turns off after the LINE VOLTAGE LED goes off.

Cause: The power supply has exceeded the capacity of the circuit breaker.

Solution: Check the circuit breaker for proper amperage rating.
Check the power cable for a short or loose connection.

Cause: The voltage to the power supply is too low.

Solution: The incoming line voltage should be 175 ± 5 VAC (minimum) for 208/240V power supplies and 350 ± 5 VAC (minimum) for 400V and 480V power supplies.

Problem: The power supply shuts off after it is turned on.

Cause: The retaining cap is loose.

Solution: Tighten the retaining cap.

Problem: The arc does not transfer after three seconds.

Cause: The three-second time-out for the pilot arc has occurred.

Solution: Press the torch start button again.

Cause: The work clamp is not connected or it is broken.

Solution: Connect or repair the work clamp.

Problem: The arc blows out, but re-ignites when the torch switch is depressed.

Cause: There are faulty consumable parts.
Solution: Inspect and change the consumable parts if necessary.

Cause: The gas pressure is incorrect.
Solution: Adjust the gas pressure:

1. Ensure the gas supply is at 80-125 psi (5.5-8.6 bar) with at least 4.5 scfm (127 l/min) flow capacity.
2. At the pressure regulator, pull the the adjustment cap up to loosen.
3. At the front panel, push the **GAS TEST** switch in and hold and view pressure gauge while adjusting the pressure regulator cap. Adjust until the pressure gauge reads 70 psi (4.8 bar).
4. Release **GAS TEST** switch and push the adjustment cap down to secure.

Solution: Clean or replace the pressure regulator filter:

1. Always **disconnect** the gas supply hose from the pressure regulator before unscrewing the filter bowl.
2. Unscrew the filter bowl and then clean or replace filter if required. 4. If the filter element needs to be cleaned or replaced, remove the element by unscrewing the element retainer. Order filter element # 011054.
3. Replace the filter and filter bowl.
4. Reconnect the gas supply hose.

Problem: The arc sputters and hisses.

Cause: The filter bowl on the pressure regulator has water in it.
Solution: Drain the water from the filter bowl :

1. Always **disconnect** the gas supply hose from the pressure regulator before draining filter bowl.
2. Drain the bowl at the bottom by removing the red plastic cap and opening the knurled drain valve in a clockwise direction.
3. Unscrew the filter bowl and clean, if required.
4. Reinstall the filter element and filter bowl.
5. Reconnect the gas supply hose.

MAINTENANCE

PAC125T TORCH PARTS REMOVAL AND REPLACEMENT

Torch Main Body Removal and Replacement

To remove and replace the torch main body, order the torch main body with cap-on sensor switch and refer to the following procedure and Figures 5-1 and 5-2.

1. **Set the MAX43 power switch to O (off), unplug the power cable, and disconnect the gas supply. Disconnect the torch lead quick disconnect from the power supply.**
 2. Remove the 5 screws that secure the handle halves together and remove handles from torch main body, torch switch and safety trigger (Figure 5-2).
- Note for step 3: Disconnect wires by pulling on terminals. Do **not** pull on wires.
3. Disconnect the two lead terminals (blue wire in each terminal) from the two wires of the cap sensor microswitch (Figure 5-1).
 4. Disconnect the plunger wire from the torch main body by holding the plunger nut with a 1/4" (6 mm) wrench or nut driver and removing the plunger screw (Figure 5-1).
 5. Disconnect the torch main body and torch lead gas fittings using 3/8" (9.5 mm) and 1/2" (13 mm) open-end wrenches.
 6. Replace the new torch main body by reversing these instructions. Note: When connecting the plunger wire, be certain to keep the plunger wire terminal at the proper angle as shown in the Figure 5-1 inset. Tighten the plunger screw with 8 lb-in (9 kg-cm) of torque.
 7. Install the torch main body and torch switch back into the handle (Figure 5-2). Be certain that the torch switch slides into position above the safety trigger, and that trigger movement activates the switch pushbutton and then releases. While positioning the handle halves together, be careful not to pinch any wires.
 8. Replace the 5 screws to secure the handle halves together.

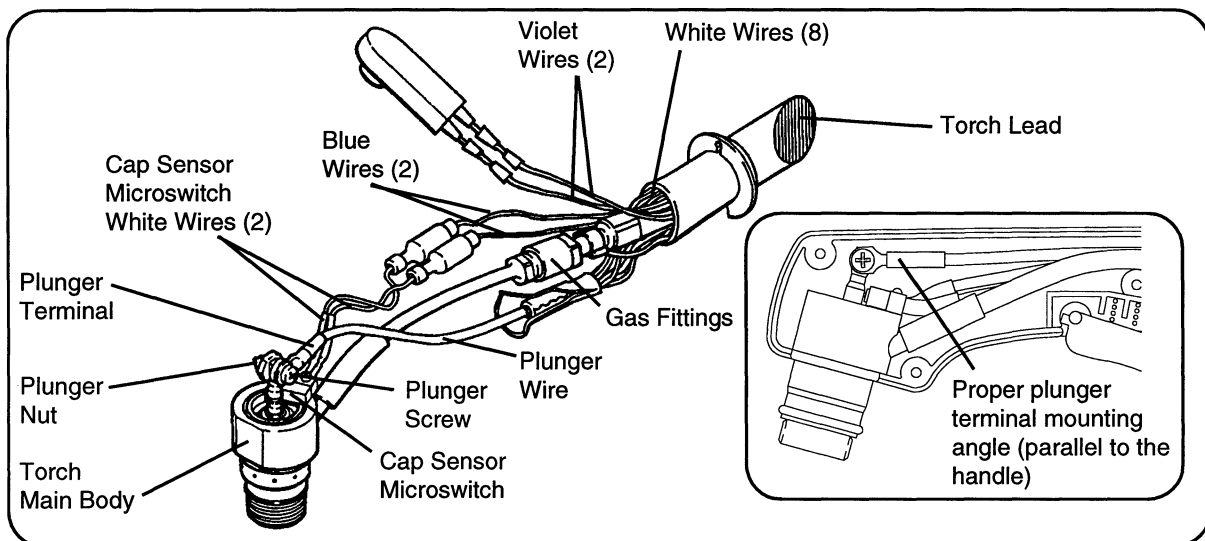

Figure 5-1 PAC125T Torch Main Body Removal

Torch Switch Removal and Replacement

To replace the torch switch, order the torch switch repair kit and refer to the following procedure and Figure 5-2.

1. **Ensure the MAX43 power switch is positioned to O (off), unplug the power cable, and disconnect the gas supply.**
2. Remove the 5 screws that secure the handle halves together.
3. Remove the torch switch from the handle.
4. Remove the torch switch by cutting the 2 splices at the torch lead (violet wires).
5. Replace the torch switch by crimping the switch wires and the violet wires from the torch lead together with the splices.
6. Install the torch switch back into the handle. Be certain that the torch switch slides into position above the safety trigger, and that trigger movement activates the switch pushbutton and then releases. While positioning the handle halves together, be careful not to pinch any wires.
7. Replace the 5 screws to secure the handle halves together.

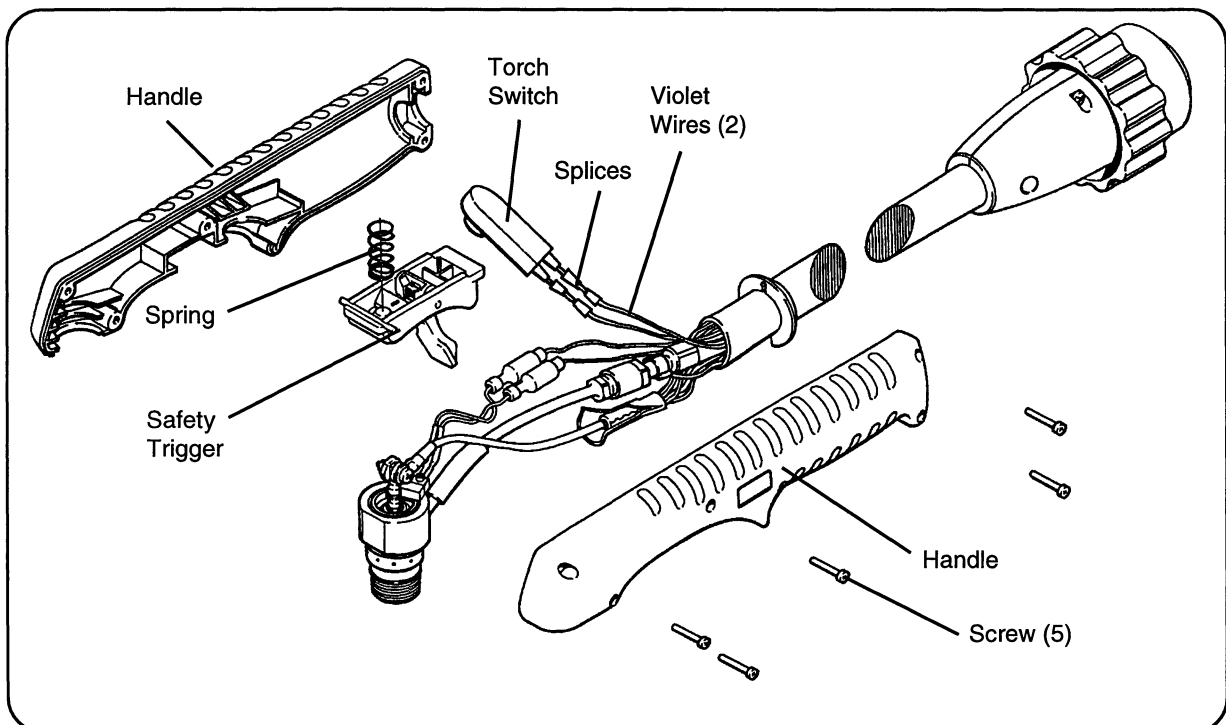

Figure 5-2 PAC125T Torch Switch Removal

MAINTENANCE

PAC121P TORCH PARTS REMOVAL AND REPLACEMENT

Repair of the PAC121P torch normally requires that either the torch main body or the torch switch be replaced.

Torch Main Body Removal and Replacement

To remove and replace the torch main body, order the PAC121P torch main body with switch (120013) and refer to the following procedure and Figure 5-3.

1. Ensure the MAX43 power switch is positioned to OFF (0), unplug the power cable, and disconnect the gas supply.
2. Remove the 5 screws which secure the handle halves together.
3. Remove the torch main body assembly and torch switch from the handle halves.
4. Slide the protective PVC tubing back away from the connections and disconnect the torch main body wires from the torch lead wires.

Note: Disconnect wires by pulling on terminals. Do **not** pull on wires.

5. Disconnect the torch main body and torch lead gas fitting using the 5/16" (8 mm) and 7/16" (11 mm) open-end wrenches.
6. Connect the new torch main body and torch lead gas fitting using the wrenches.
7. Connect the terminals connecting the two white wires from the torch lead to the black plunger wire from the torch main body.
8. Connect the bullet receptacle and plug connecting the red wire from the torch lead to the red wire from the pilot arc fitting.
9. Connect the bullet receptacles and plugs connecting the two blue wires from the torch lead to the white wires from the cap sensor microswitch.
10. Slide the protective PVC tubing back over the connections.
11. Install the torch main body and torch switch into one of the handle halves. While positioning the handle halves together, be careful not to pinch any wires. Be especially careful around the torch switch retainers.
12. Replace the 5 screws to secure the handle halves together.

Torch Switch Removal and Replacement

To remove and replace the torch switch, order the torch switch and 2 splices

1. Ensure the MAX43 power switch is positioned to OFF (0), unplug the power cable, and disconnect the gas supply.

MAINTENANCE

2. Remove the 5 screws which secure the handle halves together.
3. Remove the torch main body assembly, torch switch and wire bundle from the handle halves.
4. Slide the protective PVC tubing back away from the connections.
5. Remove the torch switch by cutting the 2 splices at the torch lead (violet wires).
6. Replace the torch switch by crimping the switch leads and the violet leads from the torch lead together with the splices.
7. Slide the protective PVC tubing back over the connections.
8. Install the torch main body, torch switch and wire bundle into one of the handle halves. While positioning the handle halves together, be careful not to pinch any wires. Be especially careful around the torch switch retainers.
9. Replace the 5 screws to secure the handle halves together.

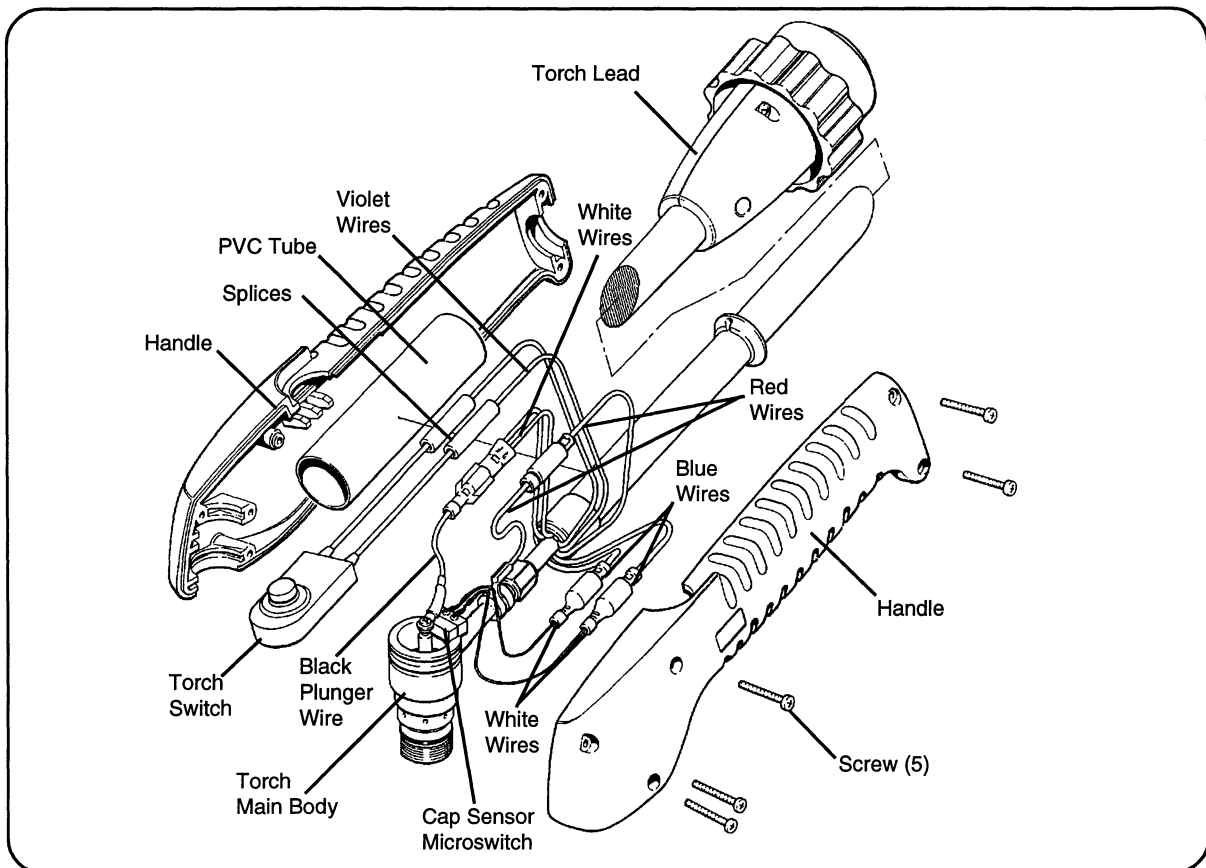

Figure 5-3 PAC121P Torch Assembly

MAINTENANCE

PAC125M TORCH PARTS REMOVAL AND REPLACEMENT

Repair of the PAC125M machine torch normally requires replacement of the torch main body and/or the torch lead. Order the torch main body with switch. Refer to Figure 5-4 and perform the steps below.

Removal

1. **Set the MAX43 power switch to O (off), unplug the power cable, and disconnect the gas supply. Disconnect the torch lead quick disconnect from the power supply.**
2. Unscrew the retaining cap and remove the remaining parts (nozzle, electrode and swirl ring).
3. Unscrew the positioning sleeve from the torch sleeve and slide it back along the lead and out of the way.
4. Cut the plastic ties holding the high-current wire to the lead. Note the position of the ties for reassembly.
5. Remove the heat shrink to expose the high-current pin and receptacle connection. Disconnect the pin from the receptacle.

Note for step 6: Disconnect wires by pulling on terminals. Do **not** pull on wires.

6. Remove the heat shrink from the cap sensor microswitch connectors (blue wires from the lead and white wires from the microswitch) to expose the terminals. Disconnect the terminals.
7. Disconnect the torch main body and torch lead gas fitting using 3/8" (10 mm) and 1/2" (13 mm) open-end wrenches.
8. Disconnect the torch main body from the torch sleeve by using snap-ring pliers to remove the snap ring that holds the torch head to the sleeve. Remove the torch main body from the torch sleeve.

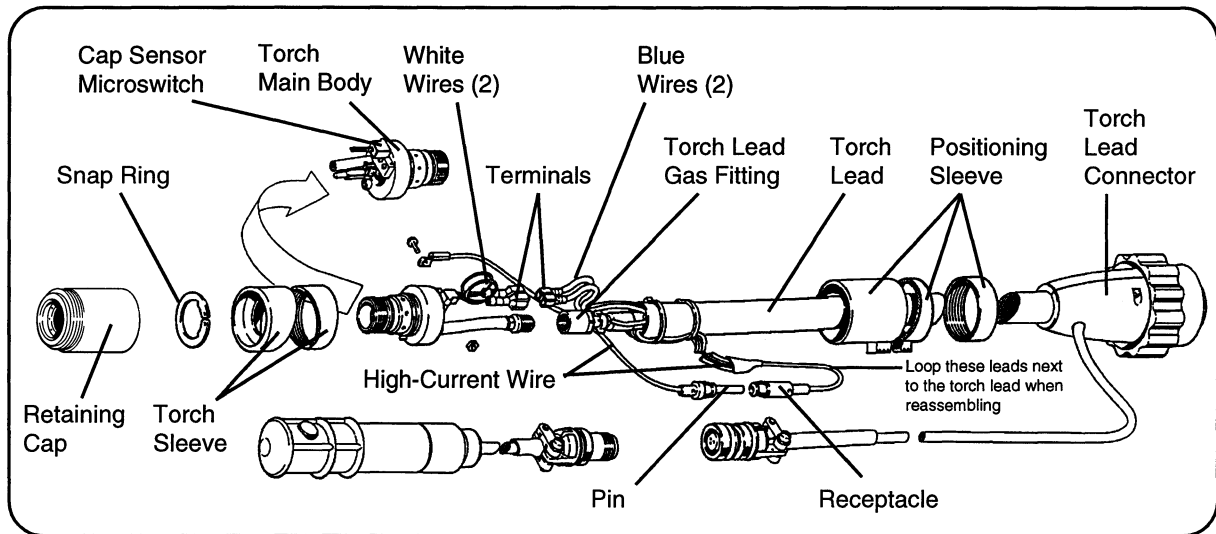

Figure 5-4 PAC125M Torch Assembly

Replacement

1. To replace the torch main body to the torch sleeve, line up the anti-rotation screw on the torch head to the locating hole in the torch sleeve.
2. Insert the torch main body into the torch sleeve and using the snap-ring pliers, secure the torch body to the sleeve with the snap ring.
3. Connect the torch main body to the torch lead gas fitting using 3/8" (10 mm) and 1/2" (13 mm) open-end wrenches. Torque to 70 in-lbs.
4. Slip 2 small pieces of heat shrink over the cap-sensor microswitch wires and connect the white wires to the blue wire terminals on the torch lead. Slide the heat shrink over the terminals and apply heat.
5. Slip a large piece of heat shrink over the high-current wire and connect the pin to the receptacle. Slide the heat shrink over the pin-receptacle connection and apply heat.
6. Loop the high-current wire next to the torch lead and secure with 2 plastic ties. Be certain that there is slack between the high-current wire and the torch lead gas fitting.
7. Slide the positioning sleeve back down over the torch lead and screw it into the torch sleeve. Be certain not to pinch any wires when screwing sleeves together.
8. Install the proper consumables into the torch. When the retaining cap is tightened, the microswitch will click, indicating that the torch main body has been replaced correctly.

MAINTENANCE

QUICK DISCONNECT O-RING REMOVAL AND REPLACEMENT

The quick disconnect O-ring (044009) on the torch leads is required to provide a tight seal between the quick disconnect and receptacle on the power supply, so that the plasma gas does not leak during cutting. To remove and replace the O-ring in the event of damage or wear, proceed as follows and refer to Figure 5-5.

1. **Set the MAX43 power switch to OFF (O), unplug the power cable, and disconnect the gas supply.**
2. Disconnect the torch lead quick disconnect from the receptacle on the power supply.
3. Remove the O-ring from the quick disconnect as shown on Figure 5-5 using needle nose pliers, tweezers, etc.
4. Replace O-ring. Ensure it seats properly.

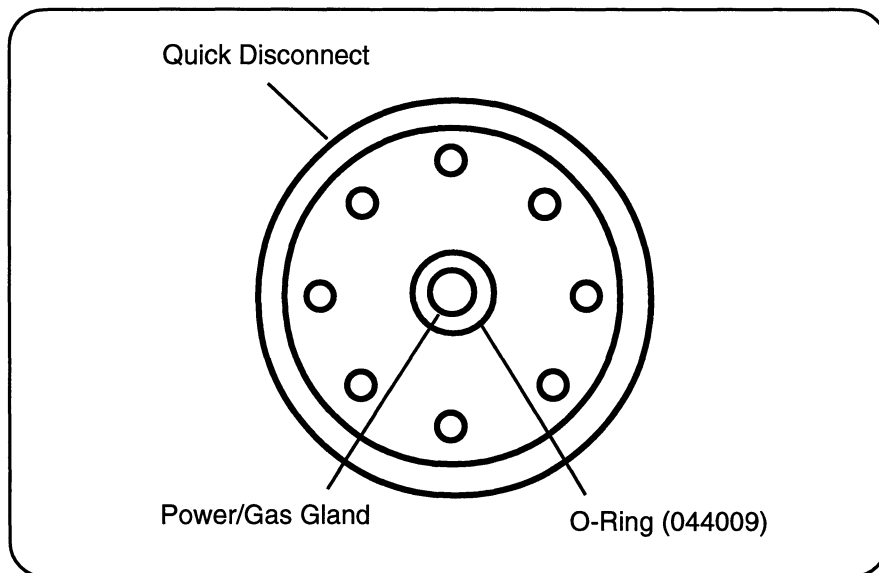

Figure 5-5 Quick Disconnect O-Ring Removal and Replacement

Section 6 MAX43 PARTS LIST

In this section:

MAX43 Power Supplies with PAC125T Torch and Leads	6-2
MAX43 Power Supplies with No Torch	6-2
MAX43 CE 400V Power Supply	6-3
MAX43 CE 400V Hand and Machine Systems	6-3
Torch Assemblies and Leads	6-4
PAC125T Torch Assembly and Lead	6-4
PAC121P Torch Assembly and Lead	6-6
PAC125M Torch Assembly and Lead	6-8
On/Off Pendant	6-8
Shielded Consumable Parts	6-10
Nonshielded Consumable Parts	6-12

PARTS LIST

MAX43 POWER SUPPLIES WITH PAC125T TORCH AND LEADS

071111	208-240 VAC, 1 Ph, 60 Hz w/15 ft (4.5 m) lead
071045	208-240 VAC, 1 Ph, 60 Hz w/25 ft (7.6 m) lead
071046	208-240 VAC, 1 Ph, 60 Hz w/50 ft (15.2 m) lead
071112	480 VAC, 3 Ph, 60 Hz w/15 ft (4.5 m) lead
071056	480 VAC, 3 Ph, 60 Hz w/25 ft (7.6 m) lead
071057	480 VAC, 3 Ph, 60 Hz w/50 ft (15.2 m) lead
071058	400 VAC, 3 Ph, 50 Hz w/25 ft (7.6 m) lead
071059	400 VAC, 3 Ph, 50 Hz w/50 ft (15.2 m) lead

MAX43 POWER SUPPLIES WITH NO TORCH

071044	208/240 VAC, 1 Ph, 60 Hz
071054	480 VAC, 3 Ph, 60 Hz
071055	400 VAC, 3 Ph, 50 Hz
071082 (with machine interface)	208/240 VAC, 1 Ph, 60 Hz
071083 (with machine interface)	400 VAC, 3 Ph, 50 Hz
071084 (with machine interface)	480 VAC, 3 Ph, 60 Hz

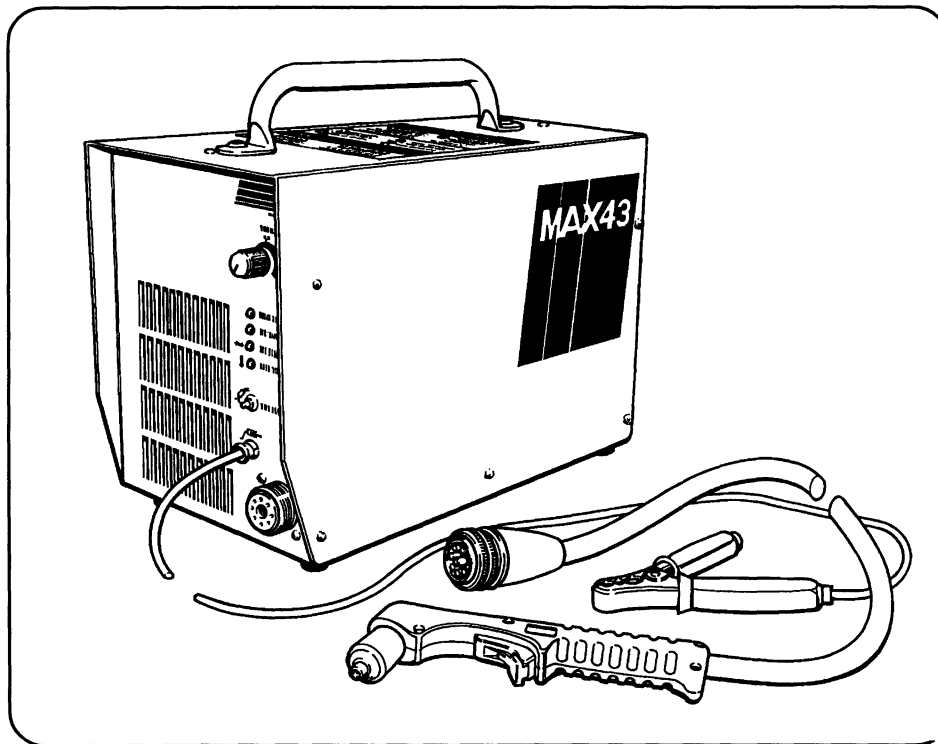

Figure 6-1 MAX43 Power Supply (Shown with the PAC125T Torch)

MAX43 CE 400V POWER SUPPLY

071114 400 VAC, 3 Ph, 50 Hz

MAX43 CE 400V HAND AND MACHINE SYSTEMS

Power Supply, PAC125T Hand Torch and Lead

071116 400 VAC, 3 Ph, 50 Hz w/15 ft (4.5 m) lead
071103 400 VAC, 3 Ph, 50 Hz w/25 ft (7.6 m) lead
071104 400 VAC, 3 Ph, 50 Hz w/50 ft (15.2 m) lead

Power Supply, PAC125M Machine Torch and Lead

071105 400 VAC, 3 Ph, 50 Hz w/25 ft (7.6 m) lead
071106 400 VAC, 3 Ph, 50 Hz w/50 ft (15.2 m) lead

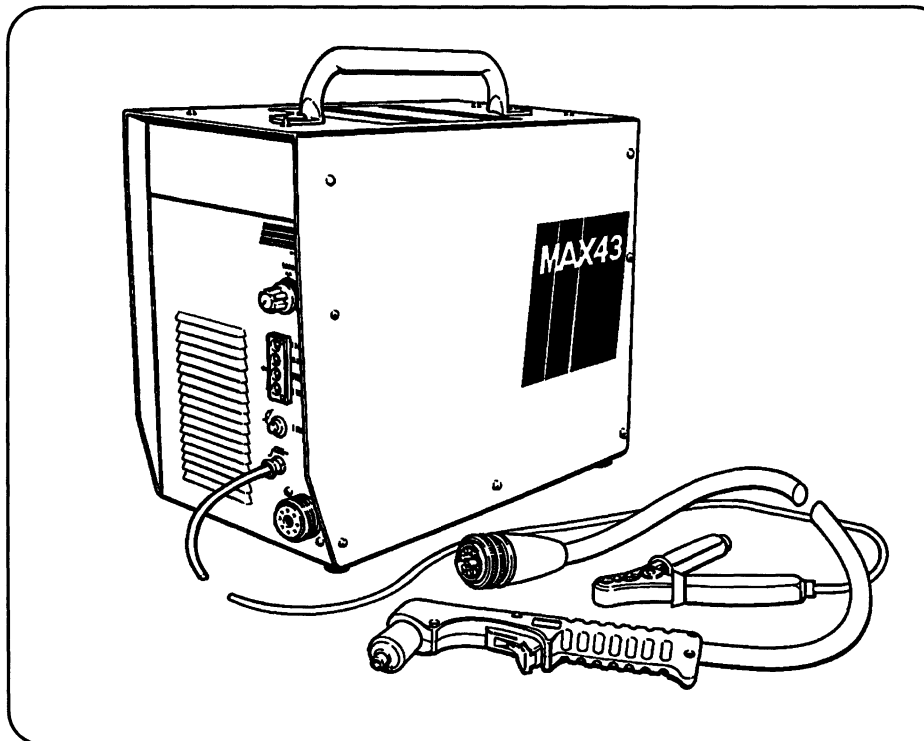

Figure 7-1 MAX43 CE 400V Power Supply (Shown with the PAC125T Torch)

PARTS LIST

TORCH ASSEMBLIES AND LEADS

PAC125T Torch Assembly and Lead (15 Ft/4.5 M) - 083127*

PAC125T Torch Assembly and Lead (25 Ft/7.6 M) - 083128**

PAC125T Torch Assembly and Lead (50 Ft/15.2 M) - 083129***

001288	Handle, PAC125T
075339	Screws, P/S, # 4 x 1/2, PH, RND, S/B
002244	Safety Trigger, PAC125T
027254	Trigger Spring, PAC 125T
128284	Switch Repair Kit
120570	Torch Main Body w/Switch, PAC125T
044016	O-Ring, Torch Main Body
044009	O-Ring, Quick Disconnect
004764	Ring, Gutcha
129479*	Torch Lead, 15 ft (4.5 m)
129352**	Torch Lead, 25 ft (7.6 m)
129353***	Torch Lead, 50 ft (15.2 m)

The following consumables are also included with the torch assembly.

120438	Nozzle
120573	Electrode
020361	Ring, Swirl
120600	Cap, Retaining
120601	Shield Cap

Consumables shown on Figure 6-5 and 6-6.

PARTS LIST

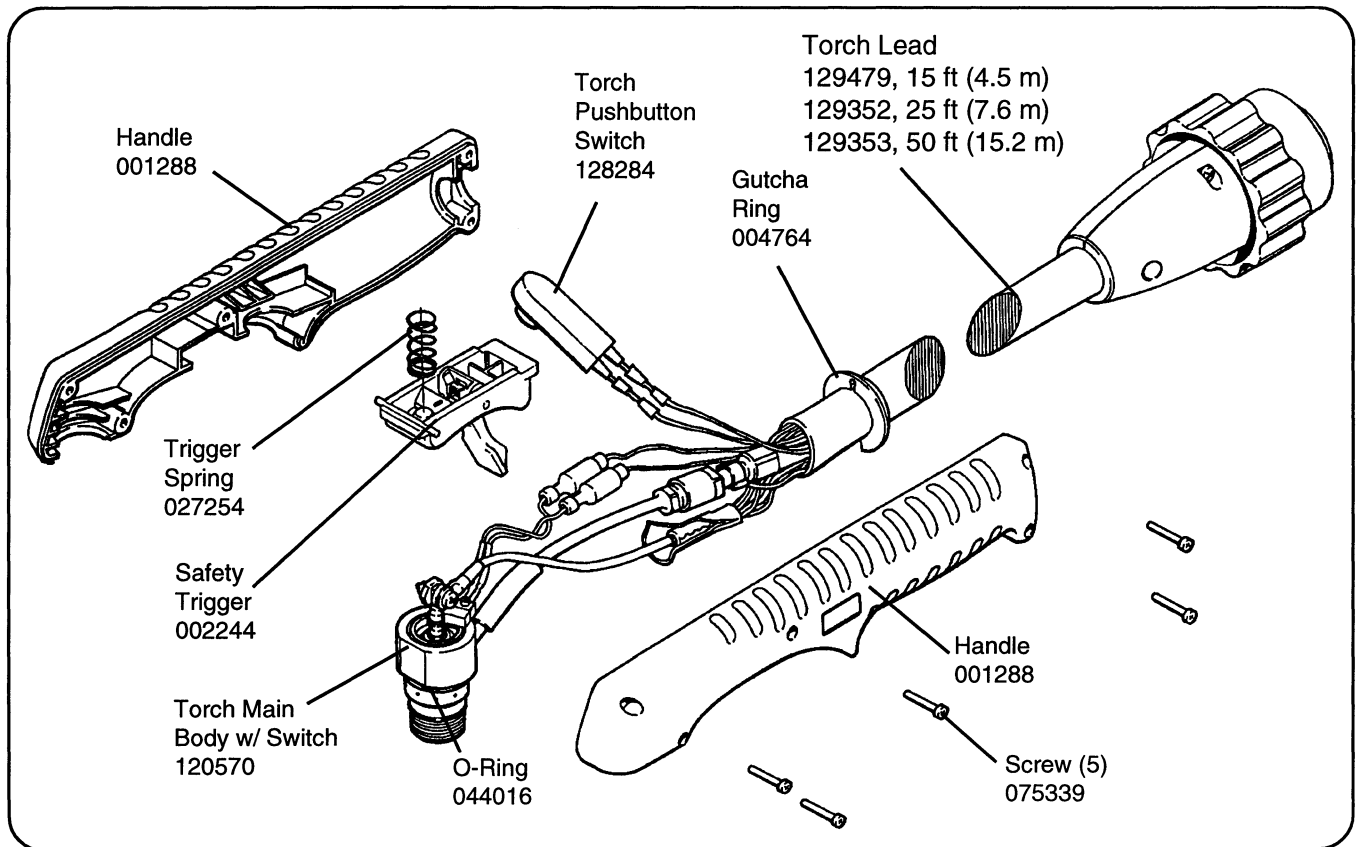

Figure 6-2 PAC125T Torch Assembly and Leads

PARTS LIST

PAC121P Torch Assembly and Lead (25 Ft/7.6 M) - 071069

001215	Handle, PAC121P
075365	Screws, P/S, # 6 x 3/4, PH, RND, S/B
005094	Switch, Torch Pushbutton
120013	Torch Main Body w/Switch, PAC121P
029391	Torch Lead, 25 ft (7.63 m)
044009	Quick Disconnect O-Ring
027283	Ring, Gutcha
046080	Tubing, 1-1/4 in. Black PVC
020350*	Nozzle
120573*	Electrode, Air
020361*	Ring, Swirl
020930*	Cap, Retaining

PAC121P Torch Assembly and Lead (50 Ft/15.2 M) - 071070

001215	Handle, PAC121P
075365	Screws, P/S, # 6 x 3/4, PH, RND, S/B
005094	Switch, Torch Pushbutton
120013	Torch Main Body w/Switch, PAC121P
029392	Torch Lead, 50 ft (15.25 m)
044009	Quick Disconnect O-Ring
027283	Ring, Gutcha
046080	Tubing, 1-1/4 in. Black PVC
020350*	Nozzle
120573*	Electrode, Air
020361*	Ring, Swirl
020930*	Cap, Retaining

* Consumables shown on Figure 6-5 and 6-6.

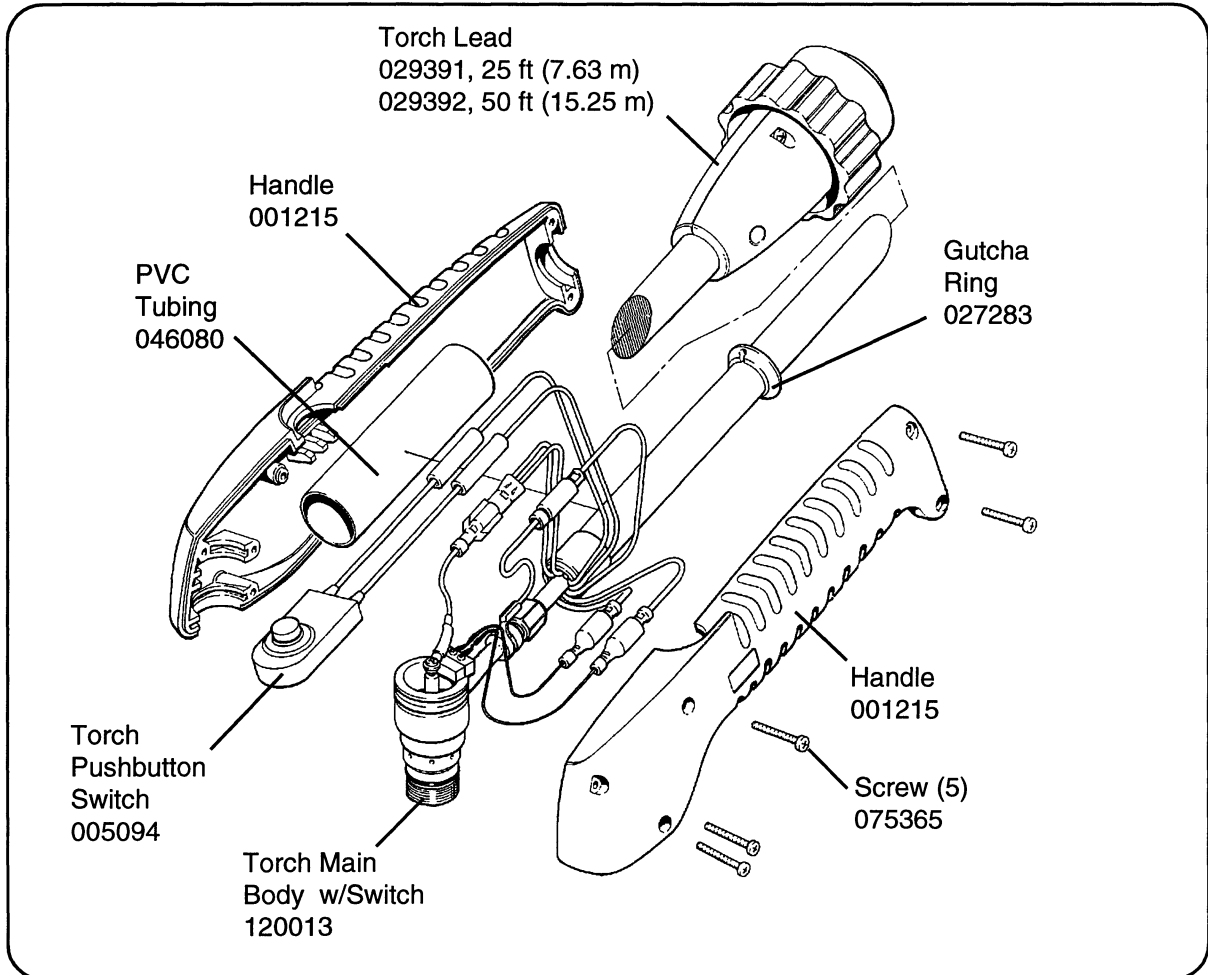

Figure 6-3 PAC121P Torch Assembly and Leads

PARTS LIST

PAC125M Torch Assembly and Lead (25 Ft/7.6 M) - 083133

020620	Sleeve, Torch Position, PAC125M
120613	Sleeve, Machine Torch, PAC125M
120583	Torch Main Body w/Switch, PAC125M
044016	O-Ring, Torch Main Body
129338	Torch Lead, 25 ft (7.6 m)
044009	O-Ring, Quick Disconnect
120023*	Nozzle, Pipe Saddle, Extended
120574*	Electrode, Extended
020361*	Ring, Swirl
020930*	Cap, Retaining

PAC125M Torch Assembly and Lead (50 Ft/15.2 M) - 083135

020620	Sleeve, Torch Position, PAC125M
120613	Sleeve, Machine Torch, PAC125M
120583	Torch Main Body w/Switch, PAC125M
044016	O-Ring, Torch Main Body
129341	Torch Lead, 50 ft (15.2 m)
044009	O-Ring, Quick Disconnect
120023*	Nozzle, Pipe Saddle, Extended
120574*	Electrode, Extended
020361*	Ring, Swirl
020930*	Cap, Retaining

On/Off Pendant - Optional

028714	On/Off Pendant w/Lead, 25 ft (7.6 m)
128061	On/Off Pendant w/Lead, 50 ft (15.2 m)
128062	On/Off Pendant w/Lead, 75 ft (23 m)

* Consumables shown on Figure 6-5 and 6-6.

PARTS LIST

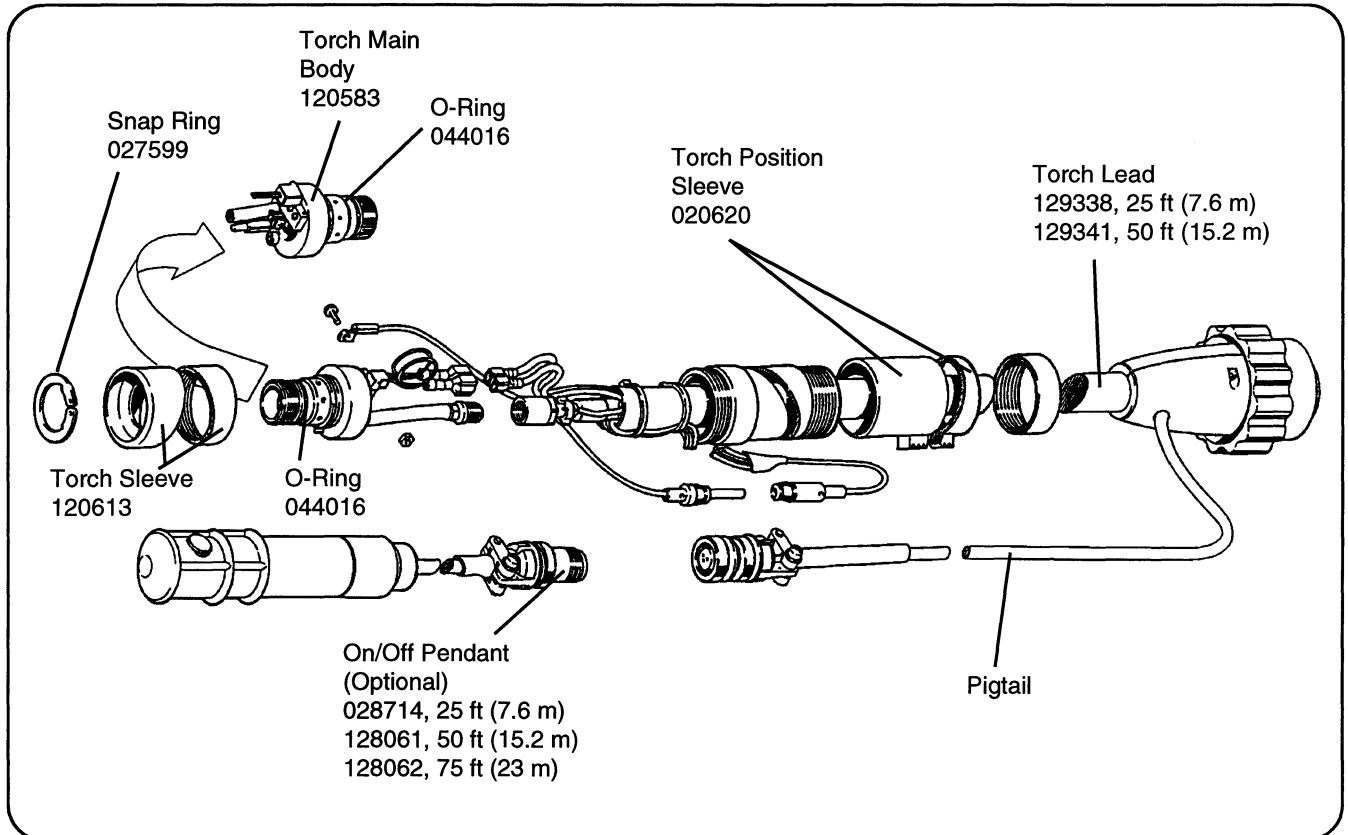

Figure 6-4 PAC125M Torch Assembly with Leads and Optional On/Off Pendant

PARTS LIST

SHIELDED CONSUMABLE PARTS

Shielded Machine Torch Consumable Parts

020930	Cap, Retaining
020361	Ring, Swirl
120573	Electrode
120574	Electrode, Extended
020350	Nozzle
020539	Nozzle, Gouging
120023	Nozzle, Pipe Saddle, Extended
020546	Nozzle, Extended

* Shielded Hand Torch Consumable Parts

120601	Shield, Hand Cutting Torch
120602	Shield, Machine Cutting Torch
120608	Shield, Gouging Torch
120600	Cap, Retaining
120438	Nozzle, 40A Shield
020539	Nozzle, Gouging
120573	Electrode
020361	Ring, Swirl

* Shielded Torch Consumable Parts Kit - 128112

001285	Box, Consumable Parts (1)
020361	Ring, Swirl (1)
120600	Cap, Retaining (1)
120573	Electrode (3)
120438	Nozzle, 40A Shield (3)
020539	Nozzle, Gouging (1)
120601	Shield, Hand Cutting Torch(1)
120602	Shield, Machine Cutting Torch(1)
120608	Shield, Gouging Torch(1)
044016	O-Ring (3)
015152	Nipple, 1/8 NPT,QDisc, Steel (1)
015570	Bushing, Reducer, 1/4 X 1/8, Brass (1)
015604	Reducer, 1/4 FPT X 1/8 NPT, Brass (1)
027055	Lubricant, Silicone 1/4 Oz Tube (1)

* CE countries must use shielded consumables when cutting with hand torches.

PARTS LIST

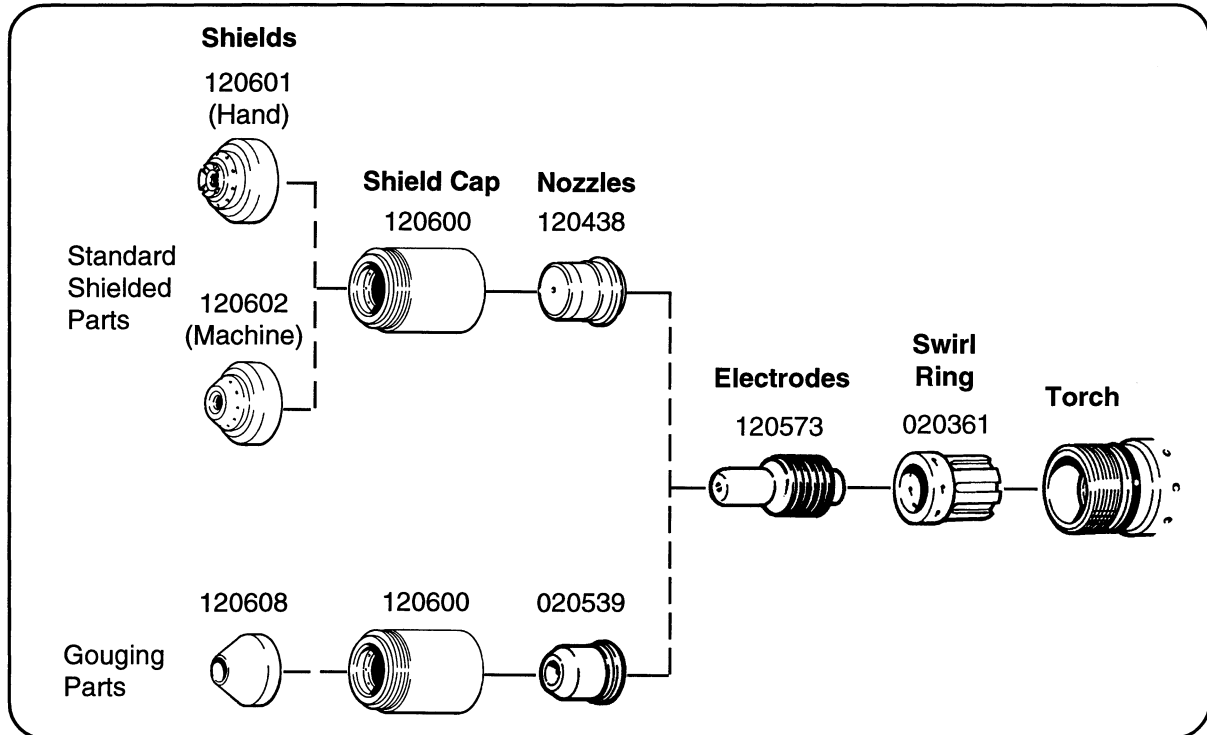

Figure 6-5 Shielded Torch Consumable Parts

PARTS LIST

UNSHIELDED CONSUMABLE PARTS

* Unshielded Consumable Parts

020930	Cap, Retaining
020361	Ring, Swirl
120573	Electrode
120574	Electrode, Extended
020350	Nozzle
020539	Nozzle, Gouging
120023	Nozzle, Pipe Saddle, Extended
020546	Nozzle, Extended

* Unshielded Hand Torch Consumable Parts Kit - 128038

001285	Box, Consumable Parts (1)
020361	Ring, Swirl (1)
020930	Cap, Retaining (1)
120573	Electrode (3)
020350	Nozzle (3)
020546	Nozzle, Extended (1)
120574	Electrode, Extended (1)
020539	Nozzle, Gouging (1)
120023	Nozzle, Pipe Saddle, Extended (1)
044016	O-Ring (3)
015152	Nipple, 1/8 NPT,QDisc, Steel (1)
015570	Bushing, Reducer, 1/4 X 1/8, Brass (1)
015604	Reducer, 1/4 FPT X 1/8 NPT, Brass (1)
027055	Lubricant, Silicone 1/4 Oz Tube (1)

Unshielded Machine Torch Consumable Parts Kit - 128039

001285	Box, Consumable Parts (1)
020361	Ring, Swirl (1)
020930	Cap, Retaining (1)
120574	Electrode, Extended (5)
120023	Nozzle, Pipe Saddle, Extended (5)
044016	O-Ring (3)
015152	Nipple, 1/8 NPT,QDisc, Steel (1)
015570	Bushing, Reducer, 1/4 X 1/8, Brass (1)
015604	Reducer, 1/4 FPT X 1/8 NPT, Brass (1)
027055	Lubricant, Silicone 1/4 Oz Tube (1)

* CE countries must use shielded consumables when cutting with hand torches.
See page 6-10 for shielded consumables.

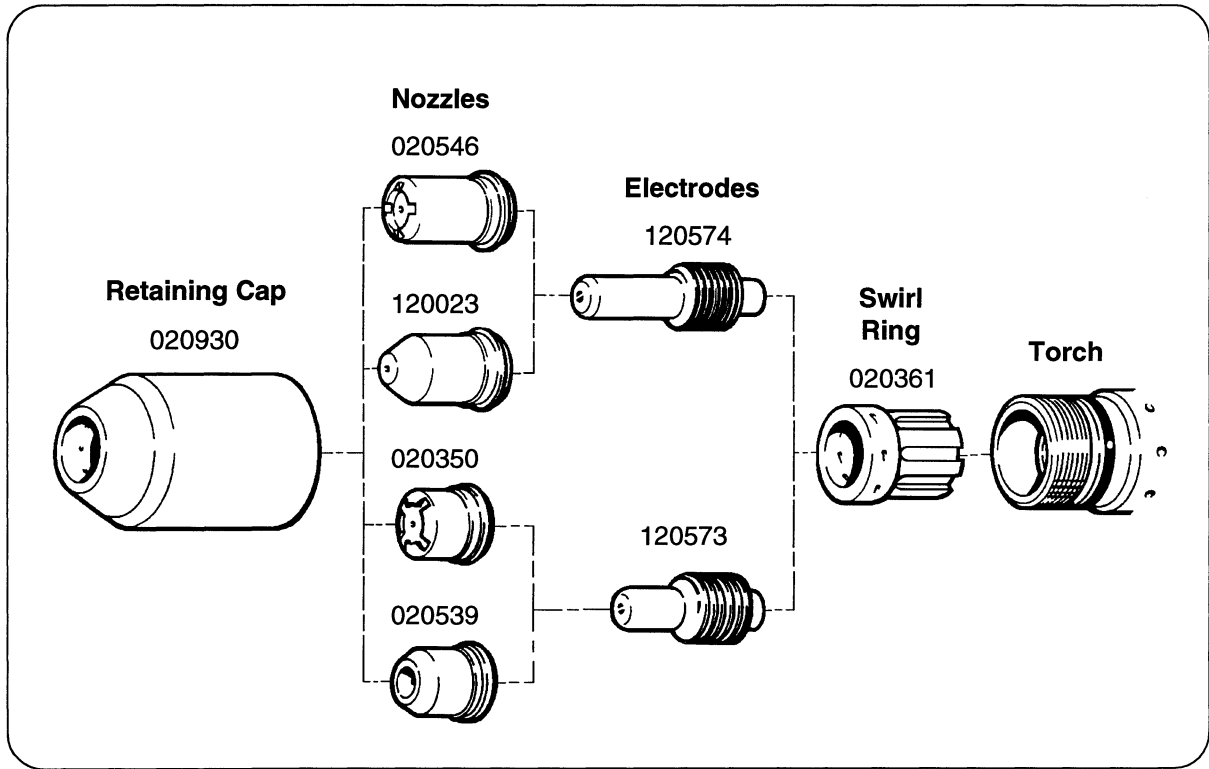

Figure 6-6 Unshielded Torch Consumable Parts

Section 7 STANDARDS INDEX

For further information concerning safety practices to be exercised with plasma arc cutting equipment, please refer to the following publications:

1. ANSI Standard Z49.1, *Safety in Welding and Cutting*
American Welding Society
550 LeJeune Road P.O. Box 351020, Miami, FL 33135
2. ANSI Standard Z49.2, *Fire Prevention in the Use of Cutting and Welding Processes*
American National Standards Institute
1430 Broadway, New York, NY 10018
3. ANSI Standard Z87.1, *Safe Practices for Occupation and Educational Eye and Face Protection*
American National Standards Institute
1430 Broadway, New York, NY 10018
4. AWS F4.1, *Recommended Safe Practices for the Preparation for Welding and Cutting of Containers and Piping That Have Held Hazardous Substances*,
American Welding Society
550 LeJeune Road, P.O. Box 351040, Miami, FL 33135
5. AWS F5.2, *Recommended Safe Practices for Plasma Arc Cutting*
American Welding Society
550 LeJeune Road, P.O. Box 351040, Miami, FL 33135
6. CGA Pamphlet P-1, *Safe Handling of Compressed Gases in Cylinders*
Compressed Gas Association
1235 Jefferson Davis Highway, Arlington, VA 22202
7. CSA Standard W117.2, *Code for Safety in Welding and Cutting*
Canadian Standards Association Standard Sales
178 Rexdale Boulevard, Rexdale, Ontario M9W 1R3, Canada
8. NFPA Standard 51B, *Cutting and Welding Processes*
National Fire Protection Association
470 Atlantic Avenue, Boston, MA 02210
9. NFPA Standard 70–1978, *National Electrical Code*
National Fire Protection Association
470 Atlantic Avenue, Boston, MA 02210
10. OSHA 29FR 1910, *Safety and Health Standards*
U.S. Government Printing Office, Washington, D.C. 20402